

**THE
NO PROBLEM
SWITCH**

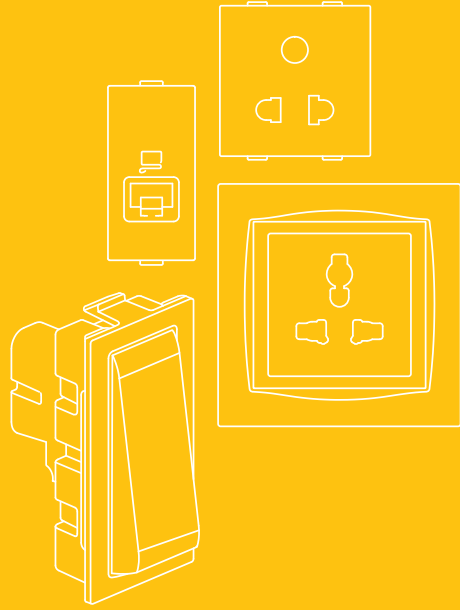

**Britzy™
SWITCHES**



10 FEATURES THAT MAKE BRITZY

THE NO PROBLEM SWITCH

THE

NO

PROBLEM

SWITCH

1

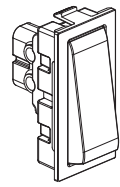

Switches that'll never get stuck in normal operation

Britzy switches are built to last over 1,00,000 operations. That's more than the ISI standard of 40,000. They don't get stuck either, so there's no wear and tear.

2

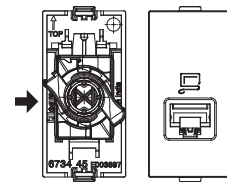

Quick and easy wiring

The RJ45 comes with built-in crimping facility which helps in quick connection of wires with the product. A simple feature that saves time and effort.

3

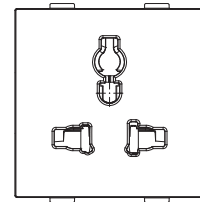

One socket fits all

The user-friendly multi-strand sockets accommodate all your gadgets — from mobile chargers to laptop chargers, Britzy fits all.

4

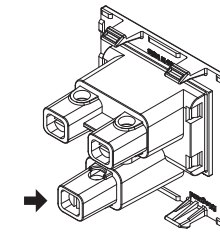

Protection from shock

All terminals and screws on switches and sockets are fully shrouded, ensuring no accidental contact and protection from shock.

5

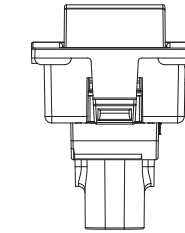

Easy to install

The flexible clip-on mechanism enables easy installation or uninstallation on the plate frame. We've made it as simple as possible.

6

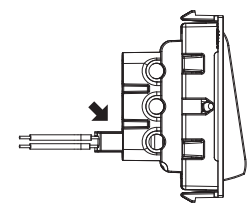

A smart way to save power

Switches with LED indicators that last long and consume much less power. It's a small but smart way to save power.

7

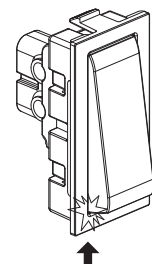

No sparks, no stress

The switches and sockets are thoughtfully crafted using high grade materials for spark-free operation.

8

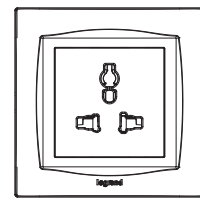

Sturdy frames for strong hold

The strong and sturdy frames of a Britzy switchboard won't allow the sockets to fall off the plugs. It's quality you can always rely on.

9

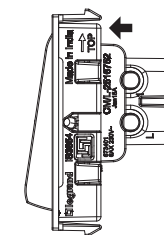

Easy-to-follow instructions

Mounting indications make sure you fix the switches and accessories the right way. There's no room for error.

10

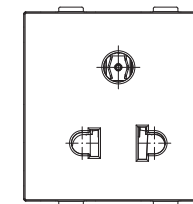

Child-proof shutters

Britzy sockets are equipped with safety shutters that ensure your child's safety. Now there's one less reason to worry.

SMART TO INSTALL MECHANISM

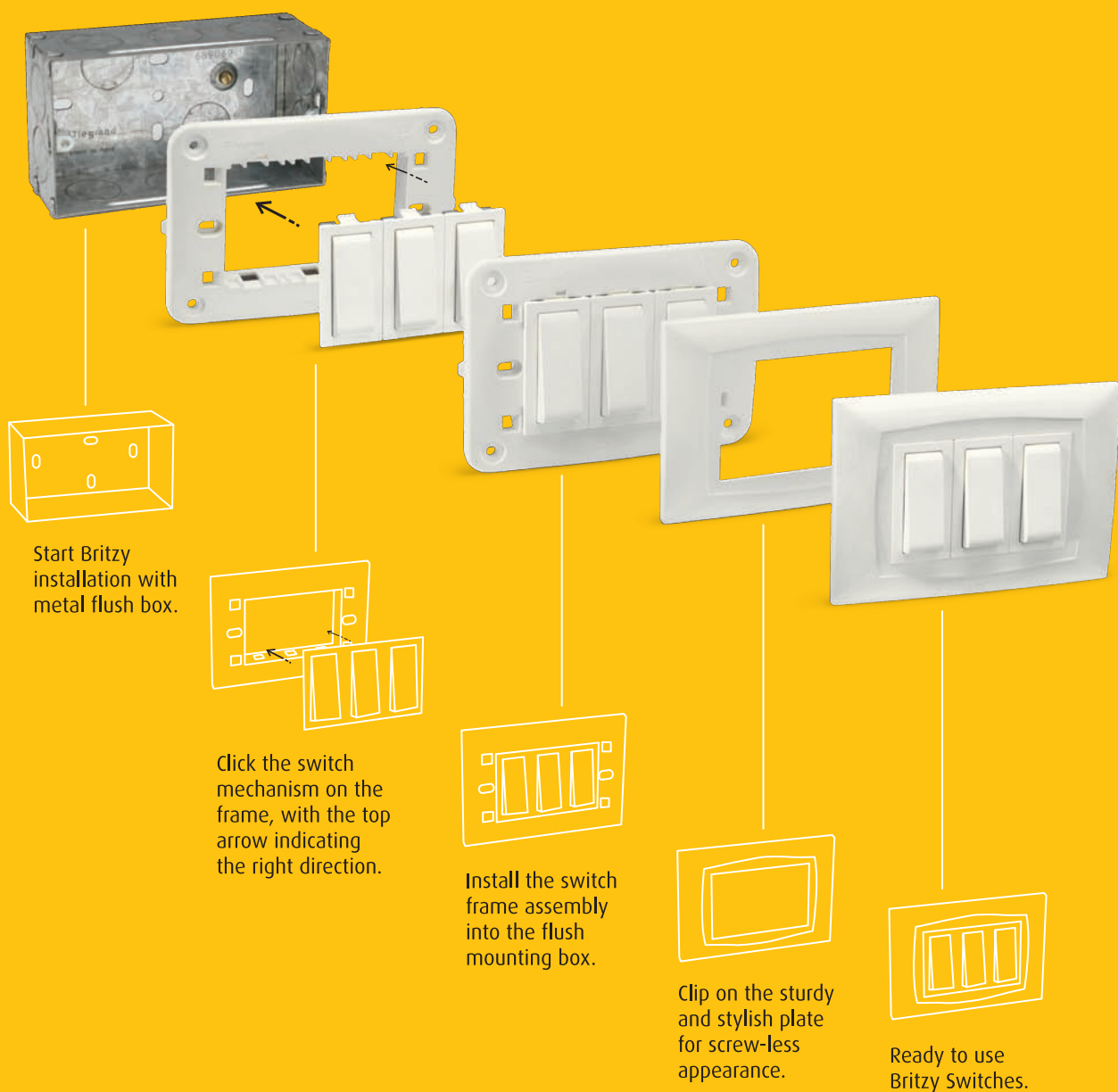

RANGE

Britzy offers a complete and customizable range of products. With switches and sockets, blank plates, data and voice connectors, electronic functions like fan regulators and buzzers, hotel functions and more, the range can easily be adapted to any kind of interiors. Perfect for your office, store and home.



Euro US socket



DP Switch 20 A, 32 A

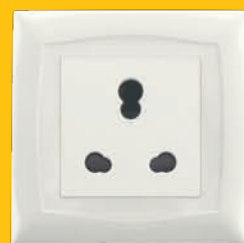

6/16 A socket



Switch 6 A, 16 A

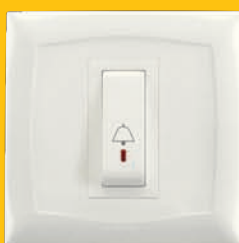

Bell push with indicator - 1 module

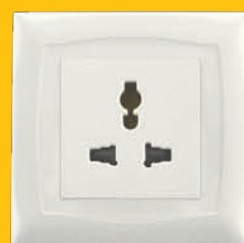

Multi-standard socket



Switch 6 A two-way



Bell push with indicator - 2 module



Universal socket
6 A - 3 pin



Switch with indicator
6 A, 16 A, 25 A

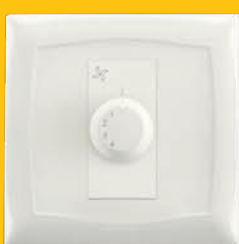

Fan regulator - 1 module



Fan regulator - 2 module



Dimmer



Flat indicator red



Key card Switch 16 A



RJ 11 Telephone socket



Buzzer



DND internal unit



Double RJ 11 Telephone socket



Bell call indicator



DND external unit



RJ 45



Skirting light



TV socket

Britzy SWITCHES



6734 01



6734 12



6734 25



6734 04



6734 52



6734 53



6734 54



6734 41



6734 44



6734 45

Technical data p. 13-14

SWITCHES

- All switches are ISI marked as per latest IS 3854:1997
- Finger-proof terminal for protection against accidental contact
- Laser marking for easy identification

PACK	CAT. NOS		No. of modules
20/200	6734 01	6 A Switch SP 1 way	01
20/200	6734 02	6 A Switch SP 2 way	01
20/200	6734 03	6 A Switch SP 1 way with Indicator	01
20/200	6734 11	16 A Switch SP 1 way	01
20/200	6734 12	16 A Switch SP 2 way	01
20/200	6734 13	16 A Switch SP 1 way with indicator	01
20/200	6734 24	25 A Switch SP 1 way with indicator	01
10/100	6734 25	20 A DP Switch with indicator	02
10/100	6734 26	32 A DP Switch with indicator	02

PUSH BUTTONS

20/200	6734 04	6 A Bell push with indicator	01
10/100	6734 06	6 A Bell push with indicator	02

SOCKETS

- Confirming to IS 1293:2005
- Shuttered socket for child safety
- Shutter open only with phase and neutral insertion simultaneously

PACK	CAT. NOS		No. of modules
10/100	6734 52	6 A 3 pin Universal socket	02
20/200	6734 53	Euro US socket	01
10/100	6734 55	6/16 A socket 3Pin	02
10/100	6734 56	25 A socket 3Pin	02
10/100	6734 54	Multistandard socket	02

DATA & VOICE

20/200	6734 41	RJ11 telephone socket	01
20/200	6734 44	Double RJ11 telephone socket	01
20/200	6734 45	RJ45 Cat 6 computer socket	01

TELEVISION SOCKET

20/200	6734 46	TV socket	01
--------	----------------	-----------	----

Bold catalogue numbers are products normally available with Legrand (India) stockists.
Cat.Nos that are not bold - delivery within 4 - 8 weeks from the date of order.
Bold packing quantity is our mandatory packing. Orders to be placed by Legrand (India) stockists in multiples of the same.

Britzy™ SWITCHES



6734 40



6734 31



6734 07



6734 66



6734 77



6734 75



6734 80



6734 82

Technical data p. 15-16

- Stripping template for exact length of insulation
- Fan regulators with safety capacitors for absorbing high surge

BUZZER

PACK	CAT. NOS		No. of modules
20/200	6734 40	Buzzer 230V	01

INDICATOR

PACK	CAT. NOS		No. of modules
20/200	6734 75	Flat indicator red	01

DIMMER & REGULATOR

5/50	6734 31	Fan regulator 100W	01
10/100	6734 30	Fan regulator 100W	02
5/50	6734 33	Light dimmer 400W	01

KEY CARD SWITCH

1/10	6734 80	16A Key card switch	02
1/10	6734 83	Keyfob credit card size for 6734 80	-

BELL INDICATOR

20/200	6734 07	Bell call indicator	01
--------	---------	---------------------	----

"DO NOT DISTURB" INDICATOR & INTERNAL CONTROL UNIT

10/100	6734 81	DND internal unit	02
10/100	6734 82	DND external unit	02

MOTOR STARTER

10/100	6734 66	25 A Motor starter	02
--------	---------	--------------------	----

ACCESSORIES

20/200	6734 71	Cable outlet	01
20/200	6734 90	Blanking plate	01
10/100	6734 72	Blanking plate	02

SKIRTING LIGHT

5/50	6734 77	Skirting light	02
------	---------	----------------	----

Bold catalogue numbers are products normally available with Legrand (India) stockists.
Cat.Nos that are not bold - delivery within 4 - 8 weeks from the date of order.
Bold packing quantity is our mandatory packing. Orders to be placed by Legrand (India) stockists in multiples of the same.

Britzy™ SWITCHES



6734 91



6734 92



6734 93







6734 96



Selection chart p. 12

WHITE PLATES WITH FRAME

Sleek and curvy plates with elegant looks comes with sturdy support frame for solid strength

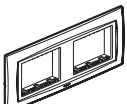
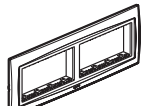
PACK	CAT. NOS		Dimensions
20/200	6734 91	 Plate & Frame 1 module	86 x 86
20/200	6734 92	 Plate & Frame 2 modules	86 x 86
10/100	6734 93	 Plate & Frame 3 modules	121 x 86
10/100	6734 94	 Plate & Frame 4 modules	146 x 86
5/50	6734 96	 Plate & Frame 6 modules	224 x 86
5/50	6734 98	 Plate & Frame 8 modules	245 x 86

WHITE PLATES WITH FRAME

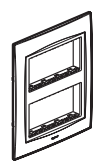
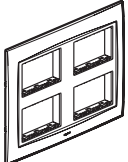
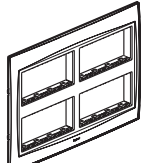
PACK	CAT. NOS		Dimensions
5/25	6734 95	 Plate & Frame 4 x 2 modules	146 x 172
10	6734 97	 Plate & Frame 12 modules	224 x 172
10	6734 99	 Plate & Frame 16 modules	245 x 172

**Plate & Frame 18 modules
will be shortly introduced**

Bold catalogue numbers are products normally available with Legrand (India) stockists.

Cat.Nos that are not bold - delivery within 4 - 8 weeks from the date of order.

Bold packing quantity is our mandatory packing. Orders to be placed by Legrand (India) stockists in multiples of the same.

Britzy™ SWITCHES



6790 60



6790 61



6790 70



6790 71



6790 63



6790 73



Selection chart for boxes and mechanisms p. 12

FLUSH MOUNTING BOXES-METAL

- Boxes are with top, bottom, side and back wall knockout for conduit entry from any direction
- Possible to break open knockout without any special tool

PACK	CAT. NOS		Dimensions
40	6890 60	Metal flush box 1 & 2 modules	75.7 x 75.7 x 50.8
40	6890 61	Metal flush box 3 modules	98.9 x 75.7 x 50.8
40	6890 62	Metal flush box 4 modules	136 x 75.7 x 50.8
40	6890 63	Metal flush box 6 modules	213.4 x 75.7 x 50.8
20	6890 64	Metal flush box 8 (2 rows x 4) modules	136.6 x 136.8 x 61
40	6890 65	Metal flush box 8 modules	231.2 x 75.7 x 50.8
10	6890 66	Metal flush box 12 (2 rows x 6) modules	215 x 145.3 x 61.2
10	6890 67	Metal flush box 16 (2 rows x 8) modules	232.8 x 147.4 x 61.2





















SURFACE MOUNTING BOXES-PLASTIC

PACK	CAT. NOS		Dimensions
10/50	6890 70	Plastic surface box 1 & 2 modules	86 x 86 x 45
5/35	6890 71	Plastic surface box 3 modules	121 x 86 x 45
5/25	6890 72	Plastic surface box 4 modules	146 x 86 x 45
1/10	6890 73	Plastic surface box 6 modules	224 x 86 x 45
2/10	6890 74	Plastic surface box 8 (2 rows x 4) modules	146 x 172 x 45
1/10	6890 75	Plastic surface box 8 modules	245.2 x 86 x 45
1/10	6890 76	Plastic surface box 12 (2 rows x 6) modules	224 x 172 x 45
1/10	6890 77	Plastic surface box 16 (2 rows x 8) modules	245.2 x 172 x 45

Metal flush box & Plastic surface box 18 modules will be shortly introduced

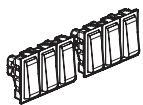
Bold catalogue numbers are products normally available with Legrand (India) stockists.
Cat.Nos that are not bold - delivery within 4 - 8 weeks from the date of order.
Bold packing quantity is our mandatory packing. Orders to be placed by Legrand (India) stockists in multiples of the same.

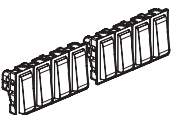
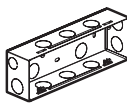
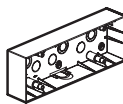
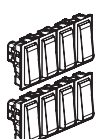
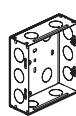
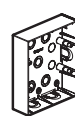
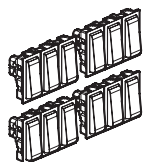
BritzyTM SWITCHES

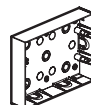
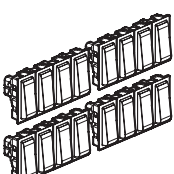
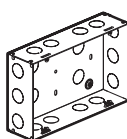
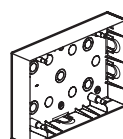
Modules	BOXES		PLATES
	Metal flush boxes	Plastic surface boxes	White
	H x W x D	H x W x D	
1 module 	6890 60 75.7 x 75.7 x 50.8	 6890 70 86 x 86 x 45	 6734 91 86 x 86
2 x 1 modules  2 modules 	6890 60 75.7 x 75.7 x 50.8	 6890 70 86 x 86 x 45	 6734 92 86 x 86
1 + 2 modules  2 + 1 modules  3 x 1 modules 	6890 61 98.9 x 75.7 x 50.8	 6890 71 121 x 86 x 45	 6734 93 121 x 86
1 + 1 + 2 modules  2 + 2 modules  4 x 1 modules 	6890 62 136 x 75.7 x 50.8	 6890 72 146 x 86 x 45	 6734 94 146 x 86
6 x 1 modules 	6890 63 213.4 x 75.7 x 50.8	 6890 73 224 x 86 x 45	 6734 96 224 x 86
8 x 1 modules 	6890 65 231.2 x 75.7 x 50.8	 6890 75 245.2 x 86 x 45	 6734 98 245 x 86
8 (2 rows x 4) modules 	6890 64 136.6 x 136.8 x 61	 6890 74 146 x 172 x 45	 6734 95 146 x 172
12 (2 rows x 6) modules 	6890 66 215 x 145.3 x 61.2	 6890 76 224 x 172 x 45	 6734 97 224 x 172
16 (2 rows x 8) modules 	6890 67 232.8 x 147.4 x 61.2	 6890 77 245.2 x 172 x 45	 6734 99 245 x 172

All sizes are H x W x D in mm

Bold catalogue numbers are products normally available with Legrand (India) stockists.

Cat.Nos that are not bold - delivery within 4 - 8 weeks from the date of order.

Bold packing quantity is our mandatory packing. Orders to be placed by Legrand (India) stockists in multiples of the same.

Britzy™ SWITCHES

■ TECHNICAL DATA RJ45 Cat.No 6734 45

		
UTP 	Cat 6	6734 45

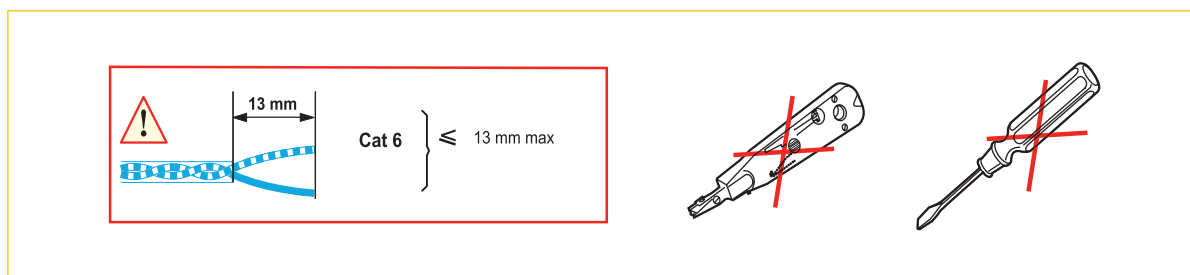
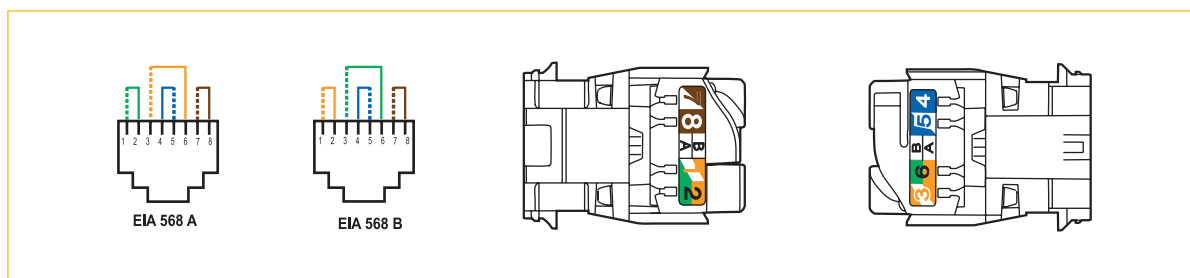
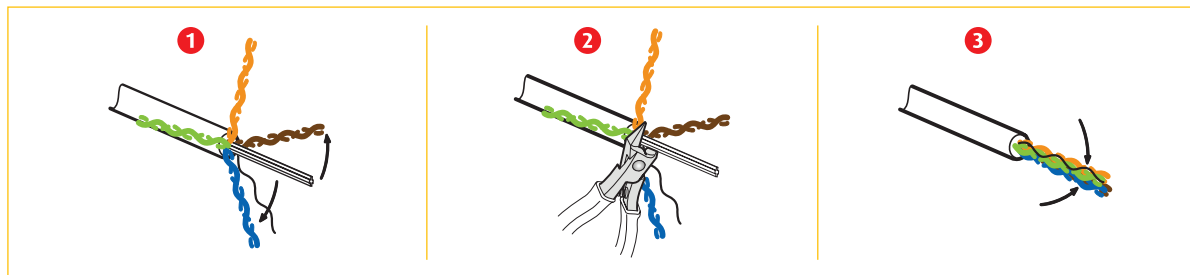
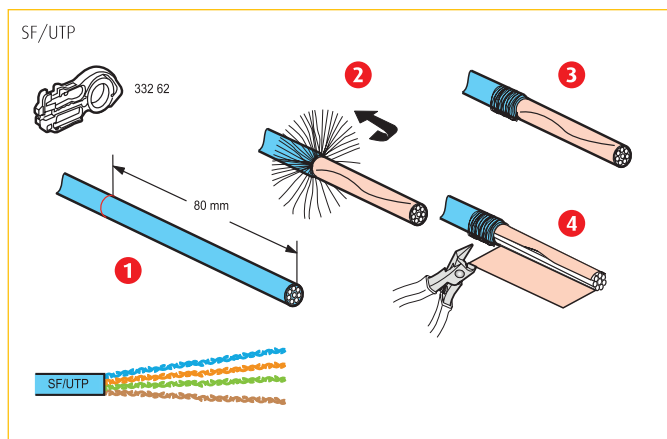
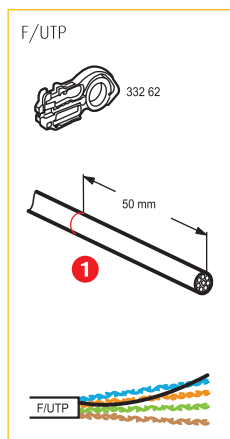
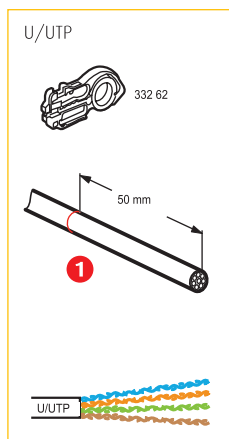

BritzyTM SWITCHES

■ TECHNICAL DATA RJ45 (continued) Cat.No 6734 45

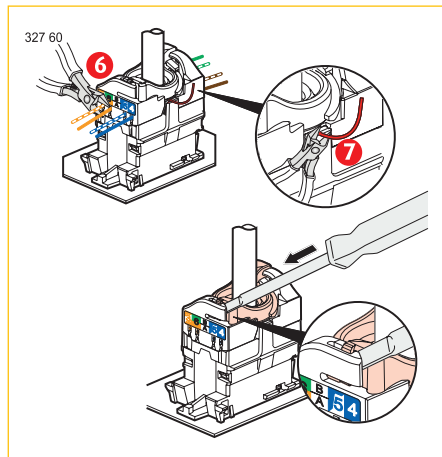
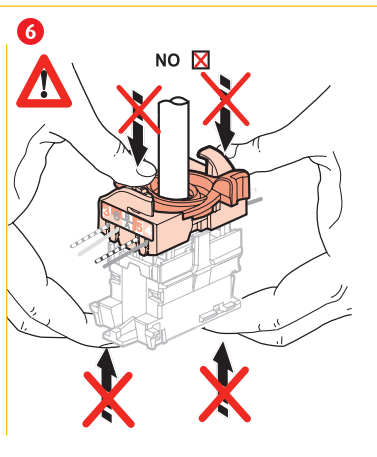
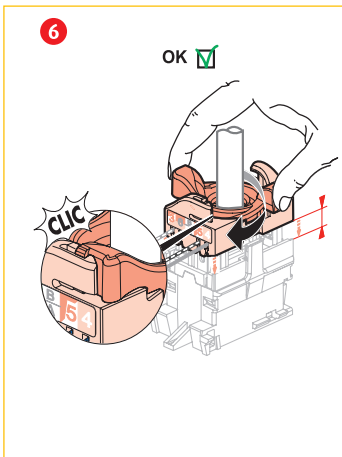
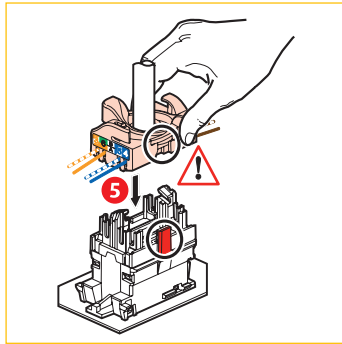
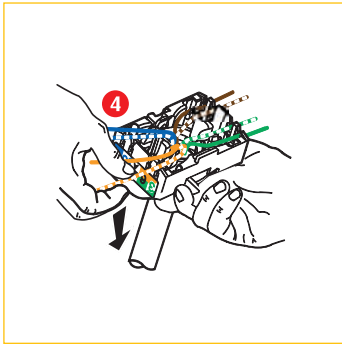
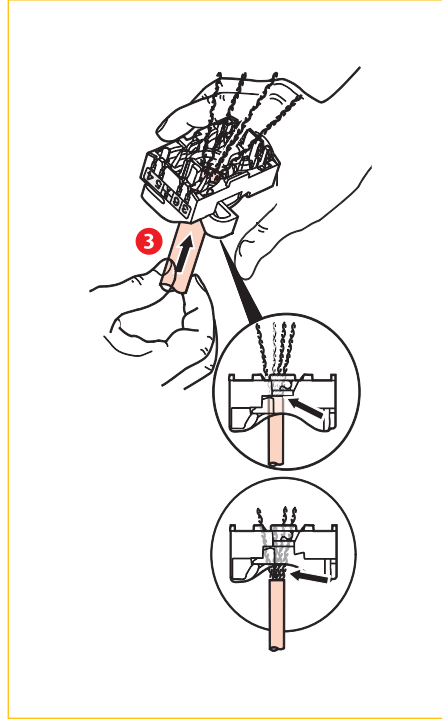
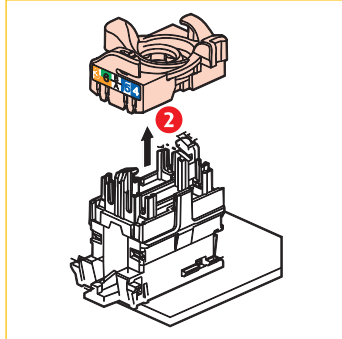
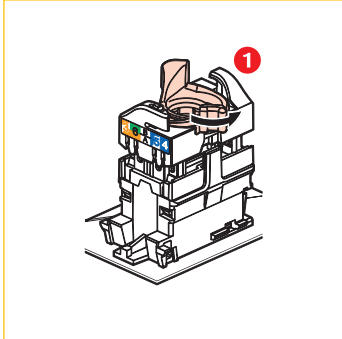

⚠ SAFETY INSTRUCTIONS

GB IE

This product should be installed in line with installation rules, preferably by a qualified electrician. Incorrect installation and use can lead to risk of electric shock or fire.

Before carrying out the installation, read the instructions and take account of the product's specific mounting location.

Do not open up, dismantle, alter or modify the device except where specifically required to do so by the instructions. All Legrand products must be opened and repaired exclusively by personnel trained and approved by Legrand.

Any unauthorised opening or repair completely cancels all liabilities and the rights to replacement and guarantees.

Use only Legrand brand accessories.

Britzy™ SWITCHES

TECHNICAL DATA KEY CARD SWITCH Cat.Nos 6734 80 - 6734 83

Characteristics

	16 A max
	16 A / 230 V~ $\mu\text{cos}\phi = 1$ 4 A / 230 V~ $\mu\text{cos}\phi = 0.6$



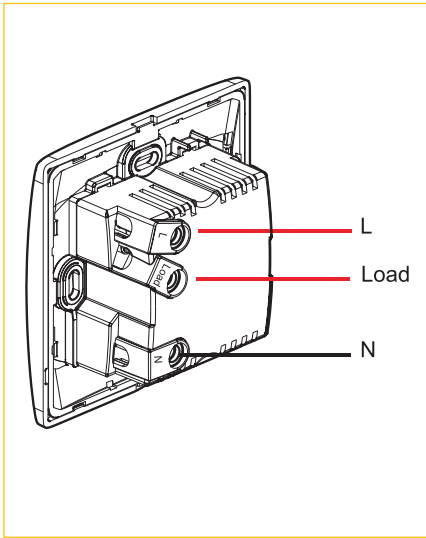

Wiring

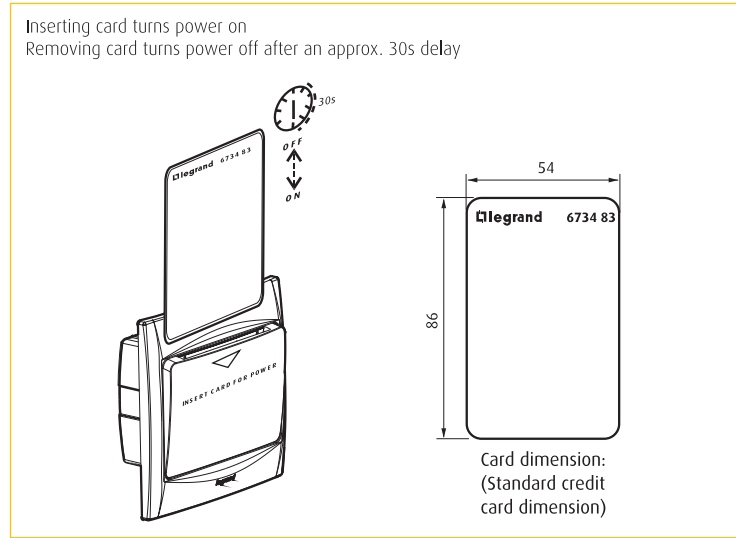

Operation



Utilization

 230 V~ 50 Hz	1 	2 	3  Ø 26 Ø 38	4  Ø 26 Ø 38
Max.	1800 W	800 W	400 VA	800 VA

- 1800 W incandescent or halogen with ferromagnetic transformer.
- 800 W inductive (motor).
- 400 VA compensated fluorescent.
- 800 VA fluorescent with electronic ballast.

Important: For load higher than indicated in the above table, use a contactor.

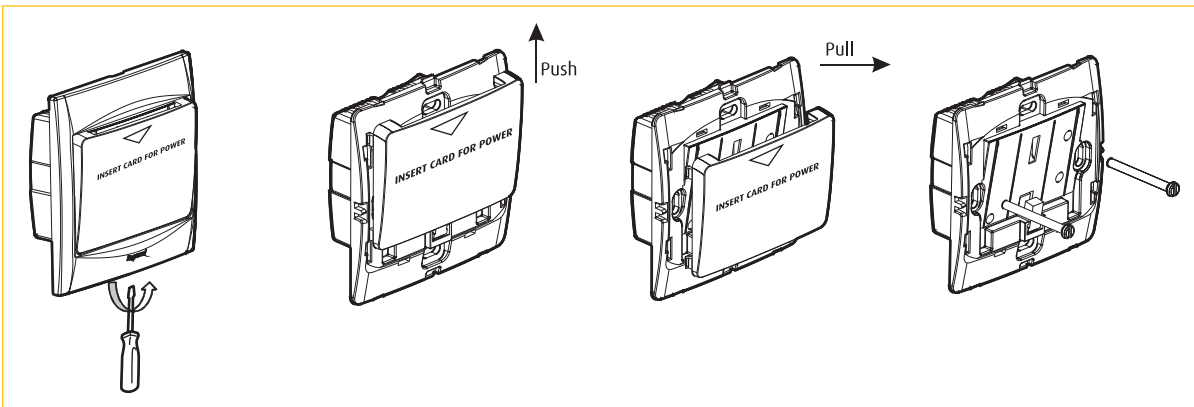

Disassembly



Britzy™ SWITCHES

■ TECHNICAL DATA HOTEL BEDROOM CALL INDICATOR AND INTERNAL CONTROL UNIT Cat.Nos 6734 81 / 6734 82

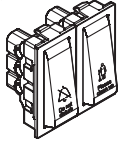
Characteristics

	Voltage			Audible signal
	230 V~ 50 Hz	2 x 2.5 mm ²	- 5 °C + 40 °C	230 V~ / 250 mA 70 - 90 dB

Description

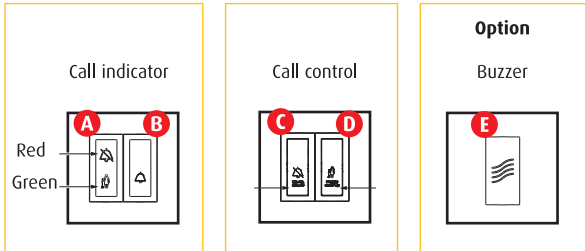

Wiring

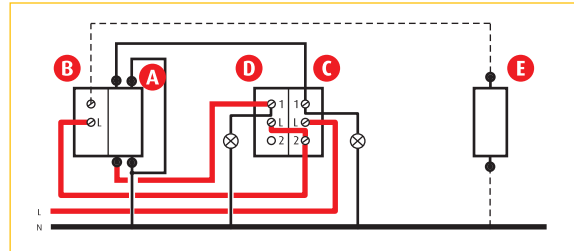

Operation

Bedroom



Corridor

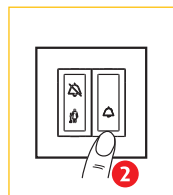
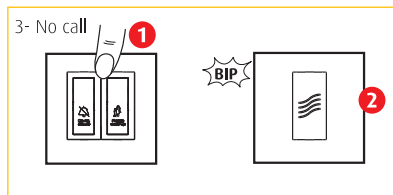
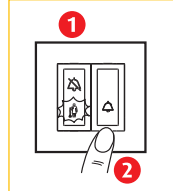
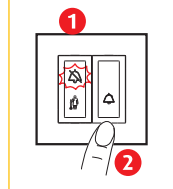

Note: If both buttons are pressed simultaneously, priority is given to the «don't disturb» call

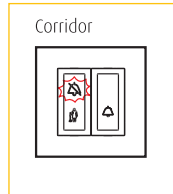
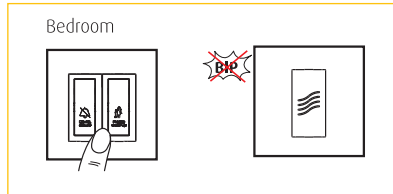

Assembly

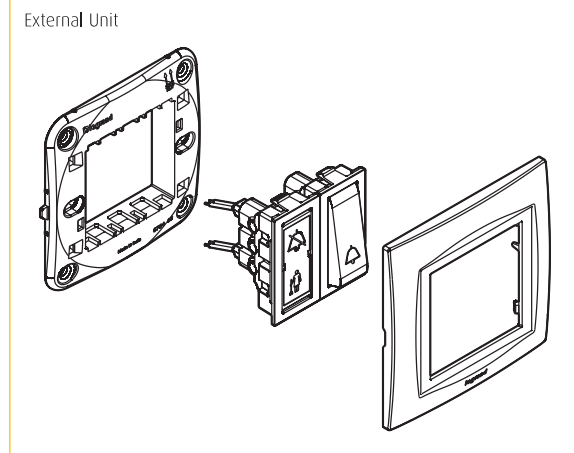
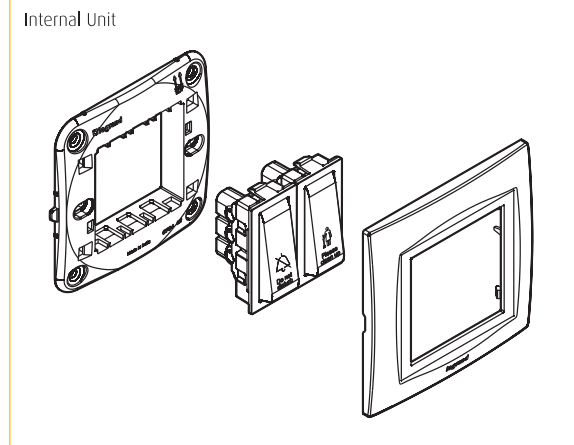

Britzy™ SWITCHES

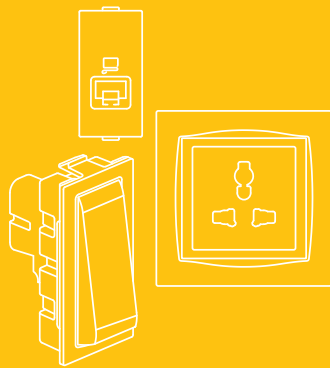

THE NO PROBLEM STORY

There is a reason why Britzy is the No Problem Switch. Imagine no more confusion at the switchboard thanks to crystal clear laser markings indicating the functions. Imagine never having to worry about the safety of your kids around sockets. Most importantly, imagine performance that lasts for over 1,00,000 clicks and looks great on your wall. Britzy thought about all the little things you didn't think about so you wouldn't need to fret about them later on, especially when using the wiring accessories.

A lot of attention goes into every switch we make to ensure safety and comfort. These small conveniences make Britzy a great switch with the safety and quality standards you expect from Legrand. As a world leader in wiring accessories with 70 years of experience and a market presence across 180 countries, Legrand leverages its knowledge, experience and best practices from across the globe to offer products that create an enhanced user experience. With Britzy, we bring you the ideal combination of design, performance, simplicity and class.

HEAD OFFICE

61 & 62, 6th Floor, Kalpataru Square, Kondivita Road,
Off Andheri-Kurla Road, Andheri (E), **MUMBAI** - 400 059.
Tel : (022) 3041 6200 | Fax : (022) 3041 6201
Website : www.legrand.co.in

REGIONAL SALES OFFICES

A-25, Mohan Co-operative
Industrial Estate, Mathura Road,
NEW DELHI - 110 044.
Tel : (011) 2699 0028 / 29 / 30,
3990 2200
Fax : (011) 2699 0047

34, 3rd Floor, Kalpataru Square,
Kondivita Road, Off Andheri-Kurla Road,
Andheri (East),
MUMBAI - 400 059.
Tel : (022) 3385 6200
Fax : (022) 3385 6201

205-208, 2nd Floor, Block - II,
White House, Kundan Bagh, Begumpet,
HYDERABAD - 500 016.
Tel : (040) 2341 4398 / 67
Fax : (040) 6636 6974

Bhakta Towers, 2nd & 3rd Floor,
Plot No. KB 22, Salt Lake, Sector - 3,
KOLKATA - 700 098.
Tel : (033) 4021 3535 / 36
Fax : (033) 4021 3537

Gee Gee Universal, 8th Floor, Door No. 2,
18/1 & 18/2, McNichols Road, Chetput,
CHENNAI - 600 031.
Tel : (044) 3024 7200, 2836 4165 / 67 / 68
Fax : (044) 2836 4169

BRANCH OFFICES

SCO 1-2-3, Second Floor, Sector 17B,
CHANDIGARH - 160 017.
Tel : (0172) 305 8631 / 32 / 33 / 34 / 35
Fax : (0172) 501 9008

IIInd Floor, Al-Latheef Building,
2/1, Union Street, Off Infantry Road,
BANGALORE - 560 001.
Tel : (080) 2286 1081, 4113 3293 / 4
Fax : (080) 2286 1078

204-205, Megapolis Square,
579, M G Road,
INDORE - 452 001.
Tel : (0731) 393 1650 / 51 / 52
Fax : (0731) 393 1653

507-510, Vth Floor, Soni Paris Point,
Jai Singh Highway, Banipark,
JAIPUR - 302 016.
Telefax : (0141) 511 3129

No. 36/2178, Syda Building, 2nd Floor,
Kaloor - Kadavanthra Road, Kaloor,
KOCHI - 682 017.
Tel : (0484) 234 2921, 658 0921
Fax : (0484) 233 392

MF-2, Datta's Lords House,
Jammi Chettu Street,
VIJAYAWADA - 520 010.
Tel : (0866) 661 1393, 664 6393
Fax : (0866) 669 9393

504, Sakar IV,
Opp. M. J. Library, Ellis Bridge,
AHMEDABAD - 380 006. Gujarat
Tel : (079) 2658 6561 / 2
Fax : (079) 2658 6563

B-15, Thirumalai Towers,
IV-D, Fourth Floor, 723. Avanashi Road,
COIMBATORE - 641 018.
Tel : (0422) 650 2728, 222 3634 / 0283
Fax : (0422) 222 3164

402, Swastik Chambers,
Near Ashwamegh Marriage Hall,
Behind HP Petrol Pump,
Off Karve Road, Erandwane,
PUNE - 411 004.
Tel : (020) 6729 5600 / 601
Fax : (020) 6729 5604

Plot No.95, II Floor, Shreyash Heights,
Ramdas Peth, VIP Road,
NAGPUR - 440 010.
Tel : (0712) 662 7857 / 58
Fax : (0712) 662 7859

AREA OFFICES

ABC Business Club 16,
Tagore Villa, Chakrata Road,
DEHRADUN - 248 001. Uttaranchal.
Tel : (0135) 271 5189 / 248 001

House No. 97, Ground Floor,
Rajgarh Main Road,
Opp. City Heart Nursing Home,
GUWAHATI - 781 007.
Tel : (0361) 245 8498

Aparna Towers, 1st Floor,
2/3, Bypass Road,
MADURAI - 625 010.
Telefax : (0452) 230 8414

Cabin No.104/105, Trade Point,
Ground Floor, Saran Chamber 1,
5, Park Road, Hazratganj,
LUCKNOW - 226 001.
Tel : (0522) 223 9044 / 7285
Fax : (0522) 223 9124

94, Udham Singh Sarani,
Ground Floor, Ashrampara,
SILIGURI - 734 001.
Tel : 94341 91635 / 98009 77780

404, Eshwar Plaza,
Dwaraka Nagar, Main Road,
VISHAKHAPATNAM - 530 020.
Tel : (0891) 663 5652
Fax : (0891) 663 9363

Cabin No. 9, Second Floor,
Madhok Trade Centre,
Madhok Complex, Ferozpur Road,
LUDHIANA - 141 001.
Tel/Fax No : (0161) 277 0301 / 304

Prime Plaza, 2nd Floor, 1st Main,
Girls High School Road,
Near PNB, Deshpande Nagar,
HUBLI - 580 029.
Mobile Nos: 98807 64338 / 98807 64339

Plot No. 359,
Saheed Nagar, 2nd Floor,
BHUBANESWAR - 751 007.
Tel : (0674) 254 0623

 **legrand**[®]

customer.care@legrand.co.in