

The cover features a blue background with a white circuit-like pattern. A large white circle is positioned in the upper right quadrant. The text is arranged in a white rectangular area at the bottom left.

Crompton

FANS CATALOGUE

2020

Crompton



LET'S
HANGOUT
GHAR PE!

Dear Customer,

We thank you for choosing Crompton as your preferred brand for fulfilling your décor choices. We are delighted that you are now part of the Crompton legacy!

Our products are crafted with an obsession to detail and have featured industry leading innovations like Anti-Dust fans and Duratech technology.

In this catalogue you will find our latest range of innovations from the Energion series of fans with energy saving BLDC motors to SilentPro range of fans that provide silent operations.

We have also included a section to help you chose the recommended design and color for your home décor.

Happy surfing !

About Us

For more than 75 years, our brand has stood for trust, reliability, dependability and excellence in the area of electrical engineering. We endeavour to provide meaningful benefits, ease of use, great design, superior performance and durability at the right price for our customers. Our range of innovative products caters to modern consumer needs like easy to clean (Anti-Dust) Fans, easy to maintain Air Coolers, Hygienic Lighting Solutions (Anti-Bac LEDs), Pumps and many more.

Today, we are a **Proud Indian Brand and a Market Leader* in the Category of Fans** with a strong presence in the other categories like pumps, water heaters, air coolers, kitchen appliances and lighting.

*As per 3rd party retail audit and industry data.

PROUDLY MADE IN INDIA

OUR RANGE OF INNOVATIVE PRODUCTS



* Up to 50% Energy Saving as compared to a regular ceiling fan operating at the same RPM.

* Most regular ceiling fans operate at 64dB. Every increase of 10 dB in noise level is perceived to be twice as loud.

* SilentPro operates at 52dB level thereby making it twice more silent than its conventional counterparts.

Awards and Recognitions

We are delighted to be awarded the National Energy Conservation Award - 6 YEARS IN A ROW!

Crompton is also awarded the Global Safety Award 2020 for Outstanding Achievement in practicing Excellent Workplace Culture in Health & Safety.



Ranked No.1 by Consumer Voice



Crompton's Star 220 ceiling fan was ranked No.1 and the only fan that delivers on the BEE 5 Star rating for energy efficiency by Consumer Voice*.

*Consumer Voice is an independent organisation that conducts independent, comparative and unbiased product trials recognized by the Ministry of Consumer Affairs.

*National Energy Conservation Award (NECA) is given every year for exceptional achievement in Energy Efficiency. This is awarded by Bureau of Energy Efficiency under Ministry of Power, Govt. of India to Appliances (Refrigerator, AC, Pump, DT, LED, Bulb, Storage Water Heater, CTV, Ceiling Fans). This year our model "HS Plus" which is 5 Star Rated Ceiling Fan has been declared the most Energy Efficient Appliance of the Year in Ceiling Fan Category. This is based on Power Rating, Production & Sales Nos. from Jul 18 to Jun 19.



Manufacturing Excellence

With improving Consumer preferences and to meet the ever increasing market demand of Crompton's durable products, we have multiple state-of-the-art manufacturing facilities at Goa & Baddi which employ the most modern technologies such as Automated Stator winding and Die Casting units which offer best in class products with highest quality standards.

Innovations driven by R&D and Consumer Research

For more than 8 decades, Crompton is known for trust, reliability and durability of its fans and is crowned as the pioneer in fan motor technology.

We leverage our robust R&D processes and capabilities, which are further enhanced by our close consumer connect - to offer superior technology based lifestyle solutions.

Innovation over the years

2016



Anti-Dust fans:

Fans with Dust-resistant Nano technology paint for hassle free cleaning and 50% less dust.

2017



Air 360 fans:

Aerodynamic blades with Anti-drag design for smoother air flow and 50% more coverage.

2018



VSense fans:

Fans with Smart Sensor technology which rotates at High Speed in low voltage conditions.

2019



Duratech fans:

Fans with Premium components & 5-year warranty designed to deliver superlative performance.

2020



Energion fans:

Energy Efficient fans with ActivBLDC motor that save up to 50% Electricity costs

2020



SilentPro fans:

Elite range of fans with aerodynamic ABS body with Silent Operation & Energy Efficient ActivBLDC motor.

Fan Selection Guide

Step 1

Compare your décor



Step 2

Select Fan Model
Select Fan colour



Step 3

Browse through the
technical details



Selection tips - Ceiling Fans

Tip 1:

Match your ceiling colour with your fan colour to make the room look spacious.

Tip 2:

To accentuate your ceiling choose the contrasting furniture colour for your fan.

Tip 3:

Metallic trims in fan go well with décor that have shiny elements within the space.

Tip 4:

Decorated fans complement spaces with classic or luxurious settings.

Tip 5:

For spaces with high maintenance, choose our anti dust ceiling fans range.

Tip 6:

For places where you need quiet comfort, choose silent operation fans.

Tip 7:

For spaces with continual requirement of fan, choose energy efficient fans.

Technical Advice

Ceiling Fan Selection

How to select your fan?

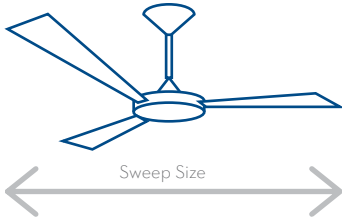

Sweep Size is referred to the entire diameter of a fan.

Speed (RPM)	Air Delivery (CFM)
315	240

Higher RPM does not mean higher air flow. Air flow / Air delivery is the only point of comparison in selecting a ceiling fan.

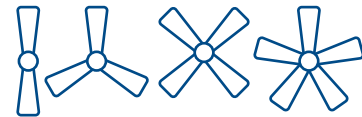

More fan blades do not give better air flow.

A four or five blade ceiling fan provides a more conventional, balanced look, whereas a fan with two or three blades possesses a modern and sleek style.

Sweep Size	Room Size
600 mm (24")	Small shop, cabin or Powder Room
750 mm (30")	6 X 10 ft
900 mm (36")	7 X 10 ft
1050 mm (42")	10 X 10 ft
1200 mm (48")	12 X 13 ft
1300 mm (52")	13 X 14 ft
1400 mm (56")	14 X 16 ft

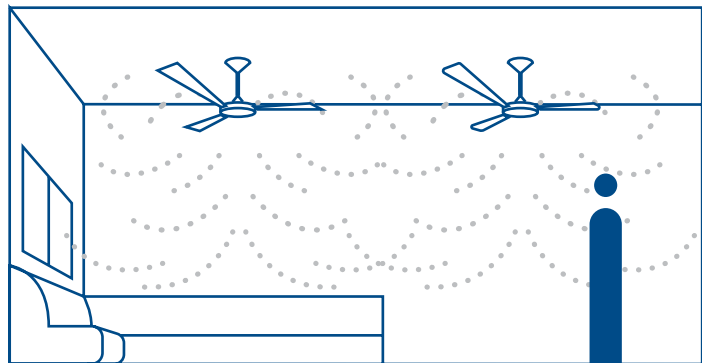

For a much more larger room, consider using two fans to balance the air circulation in all parts.

Optimal Height

For ceilings that are taller than nine feet, add 6" to the downrod for every foot of height.

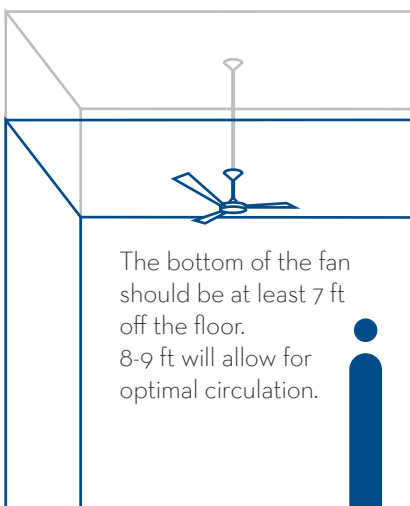

The more space between the ceiling and the blades, the better for air flow and circulation.

- 10 ft
- 9 ft
- 8 ft } Optimal height
- 7 ft
- 6 ft
- 5 ft
- 4 ft
- 3 ft
- 2 ft
- 1 ft
- 0 ft

Energy Efficiency

Lower electricity consumption means higher savings. The more stars there are, the more your savings are.



DECOR STORIES

Browse through our décor stories that help you select the right fan for your interiors. Complement your ceiling with a wide range of stylized designs that are available in many colours.



MINIMALIST DECOR

ECLECTIC DECOR

CONTEMPORARY DECOR

MODERN DECOR

INDUSTRIAL / RUSTIC DECOR

LUXURIOUS DECOR

ETHNIC DECOR

TRADITIONAL DECOR

SCANDINAVIAN DECOR



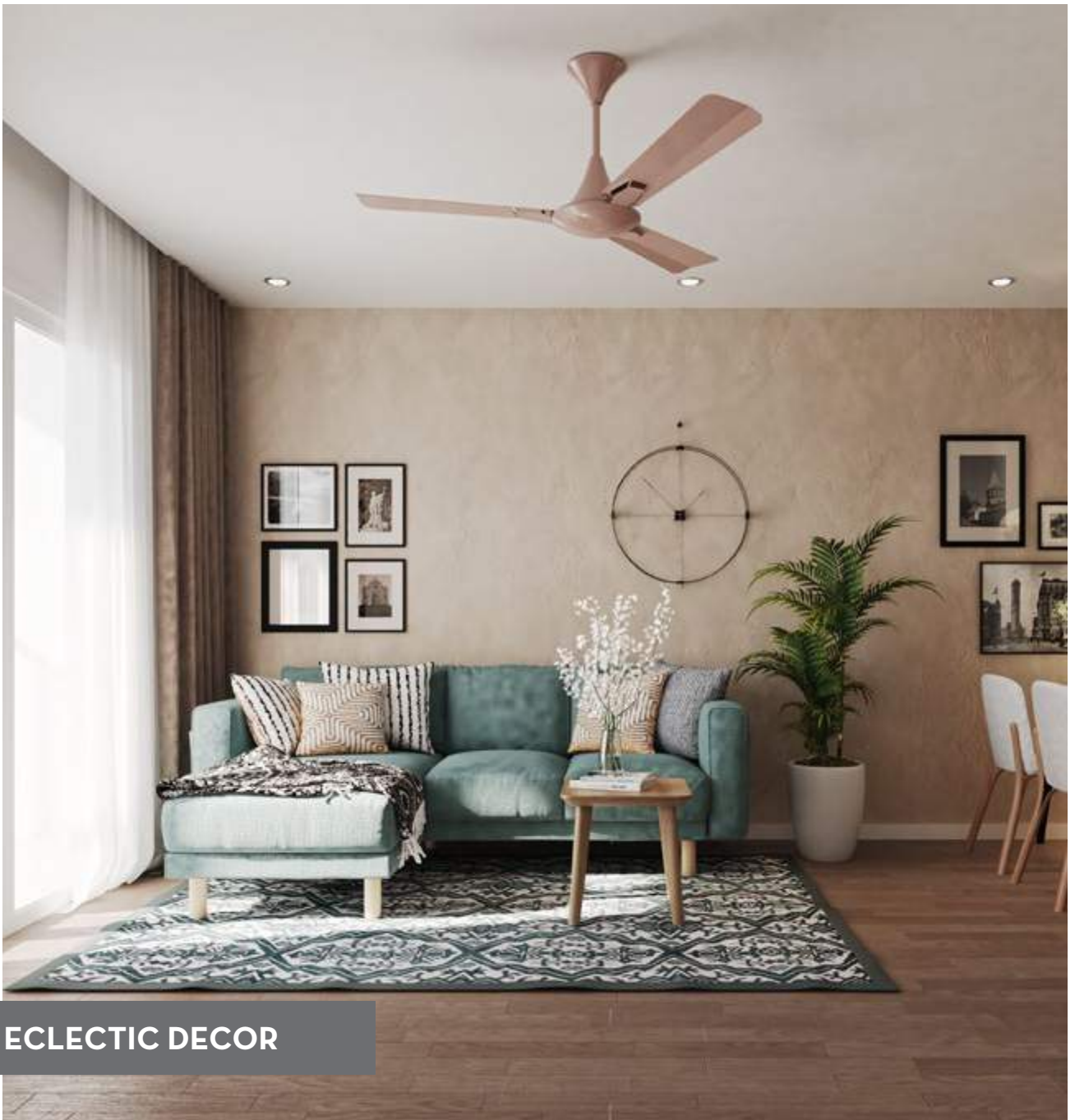

ECLECTIC DECOR

Mix it up! Old and new, vintage and radical, this design school is less about haphazard throwing together of pieces and more about being able to borrow specific styles, trends, colour combinations and more from across the decades come together to create a distinct, yet cohesive mood.

Featured: Aura2 Prime
Rose Gold
Pg no. 44

Other Recommendations:



Bruna
Powder Blue

pg. 62



Gianna
Tapioca

pg. 58



Aura2 Prime
Birken Effect

pg. 45

Other Recommendations:



Energy Stylus
Gloss Black

pg. 29



Bruna
Berry Blast

pg. 62



Aura2 Designer 2D
Bakers Brown

pg. 42

Featured: Avancer Prime Cocoa Gold | Pg no. 48

ECLECTIC DECOR





CONTEMPORARY DECOR

Contemporary styling is all about creating an aesthetic that's trendy, inclusive and feels like it belongs in the present. Right now, it's all about muted colour schemes, curated accessories and furniture with clean lines and soft edges. Work with natural elements, industrial accents and subtle prints to add your own distinctive warmth and charm.

Featured: Jura Prime
 Conch Cream
 Pg no. 55

Other Recommendations:



Gianna
 Walnut Brown

pg. 58



Markle Designer
 Vanilla Sky

pg. 61

Despite the misleading name, modern styling is rooted somewhere in the mid-20th century. Clean lines, curated pieces and a refined, unfussy approach is what it's all about. Focus on a handful of earthy tones with wood, stone or metal accents to bring it to life.

Other Recommendations:



SilentPro
Charcoal Grey

pg. 25



SilentPro
Chestnut Wood

pg. 24



Jura Designer
Marble Brown

pg. 51

Featured: SilentPro Silk White | Pg no. 24

MODERN DECOR



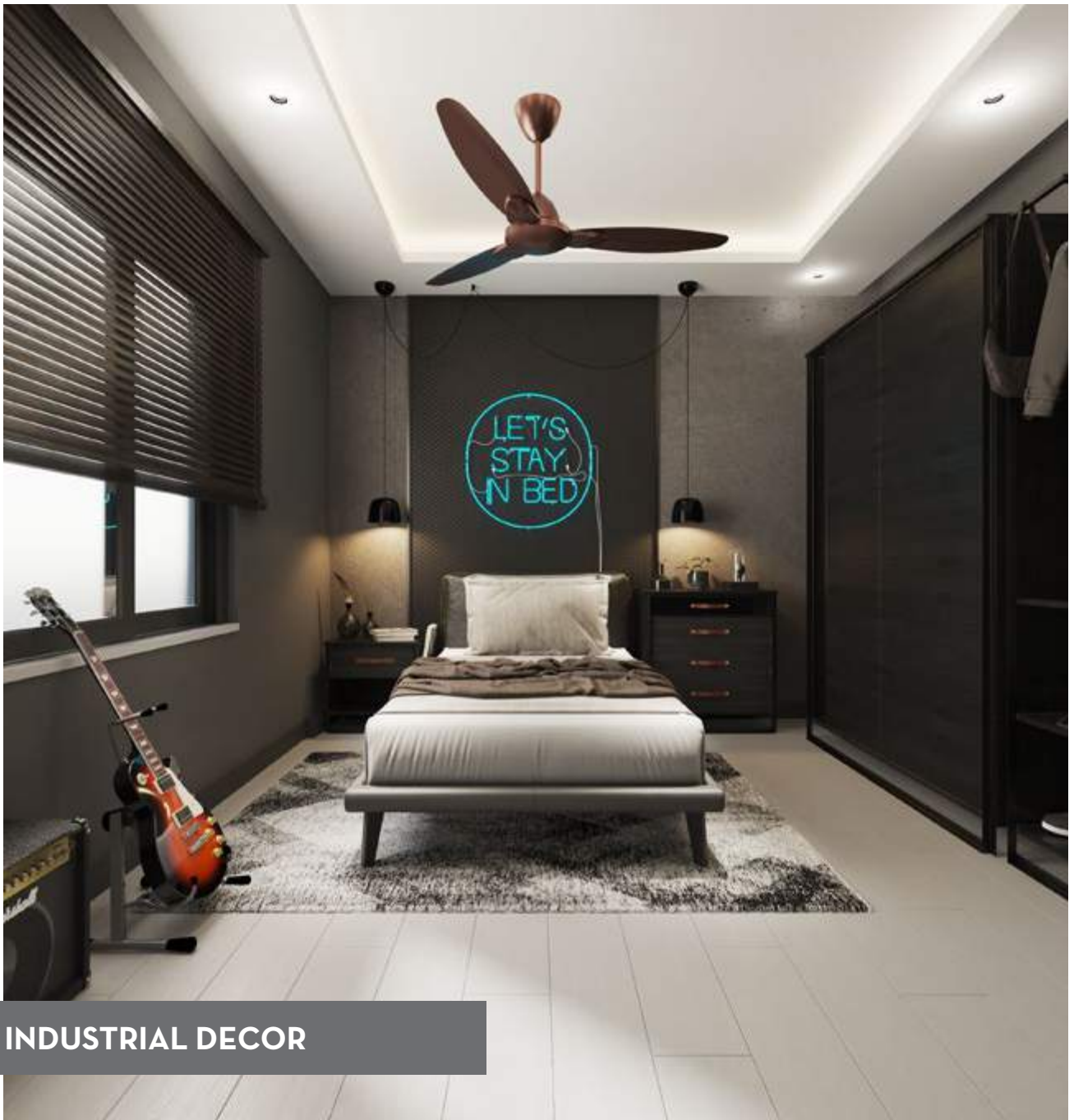

INDUSTRIAL DECOR

Born from the foundations of old warehouses, factories and mills, this style focuses on staying close to the raw nature of space. High ceilings, open plan formats, high-contrast art pieces, darker colour palettes and plenty of metal create a look that's polished yet ever welcoming and casual.

Featured: Senoprime
Roast Brown
Pg no.54

Other Recommendations:



Gianna
Roast Brown

pg. 58



Diego
Matte Black

pg. 57



Aura Prime
Onyx

pg. 47

'Champagne kisses and caviar dreams' - luxe styling is all about sophisticated self-expression, plush ornamentation and most of all - balance. Maximise comfort while adding enough interest and warmth through rich fabrics, edited accents and clean, nude palettes. There's room for everyone from the Zen-loving modernists to the whimsical maximalists to make their own style statement.

Other Recommendations:



Markle Prime
Pearl White

pg. 60



Avancer Prime
Conch Cream

pg. 49



Aura2 Designer 3d
Pearl White

pg. 41

Featured: Markle Designer Vanilla Sky | Pg no. 61

LUXURIOUS DECOR





ETHNIC DECOR

Recreating the warmth and charm of India is easy when you start with the right foundation. Choose custom-made pieces that show off your connection to the culture and handicrafts and add motifs that bring back memories of ancestral bungalows and grandma’s colourful saris. Finally, temper it all by sticking to a handful of colours, earthy elements and plenty of natural lighting.

Featured: Aura2 Designer 3d
Pearl White
Pg no. 41

Other Recommendations:



Rubio
Glow White

pg. 63



Markle Designer
Orange Rust

pg. 61



Aura Prime
Butter Scotch

pg. 46

Scandinavia-inspired, uncluttered and stylish; minimalism embodies the idea of doing more with less. While the word might conjure up visions of monochrome rooms with sparse décor, it has evolved into multiple versions that include bohemian underpinnings, retro touches and punchy colour accents.

Other Recommendations:



Aura2 Prime
Titanium

pg. 45



Aura2 Prime
Pearl White

pg. 45



Jura Bakers
Brown

pg. 56

Featured: SilentPro Charcoal Grey | Pg no. 25

MINIMALIST DECOR



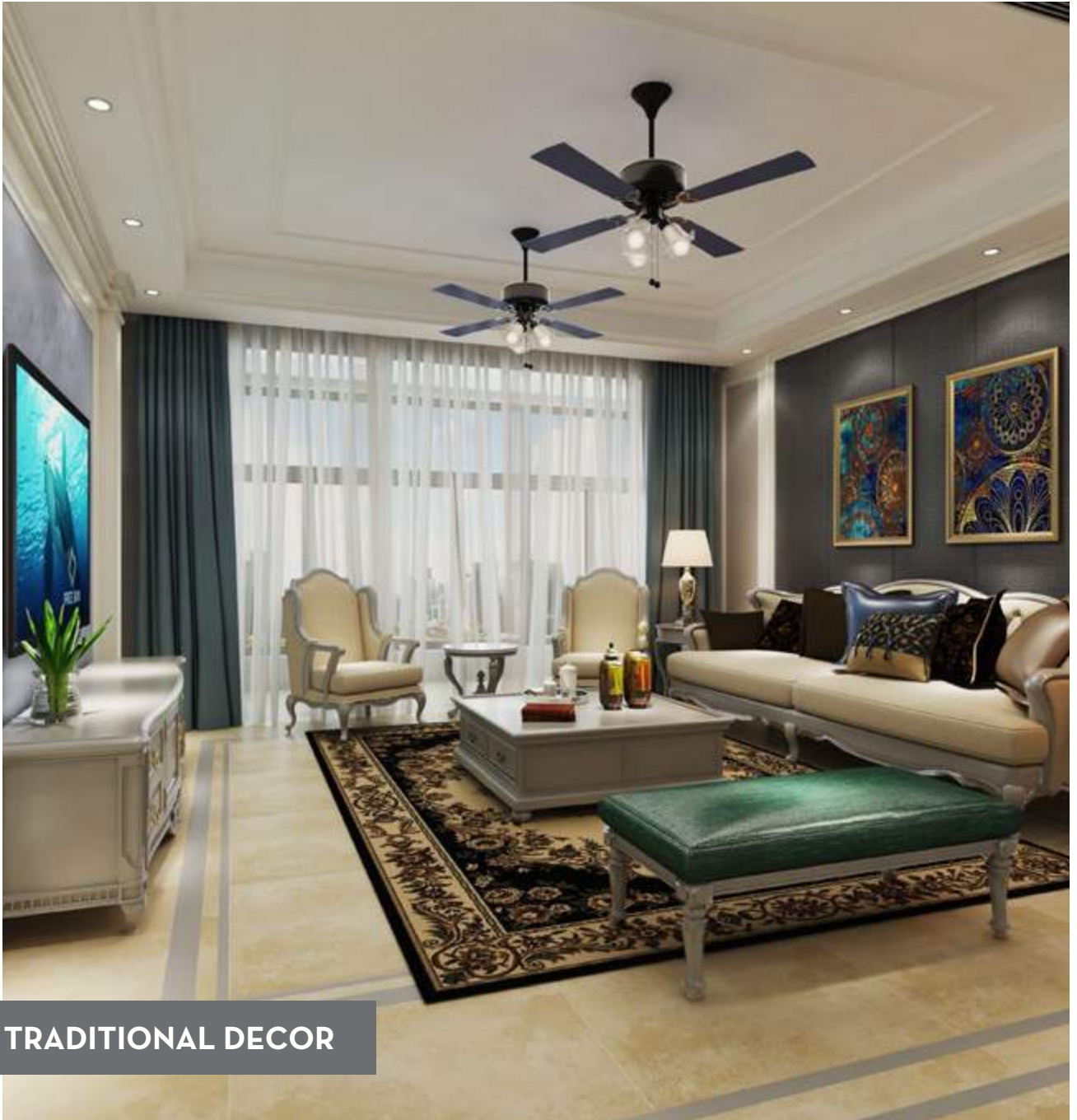

TRADITIONAL DECOR

Keep it simple and unruffled. Everything about this décor is refined and classic. From the colour choices to the furniture choices and placement symmetry, this look is all about comfort without being crowded. There are no wild cards here, just rich details and dependable harmony.

Featured: Uranus
Black Chrome
Pg no. 34

Other Recommendations:



Markle Designer
Navy

pg. 61

This design style relies on finding beauty and elegance in clean, uncluttered spaces that are still distinct and evocative. Function and form, work shoulder-to-shoulder in this aesthetic which values geometric shapes, lots of texture and neutral backdrops in new and ever-evolving ways.

Other Recommendations:



SilentPro
Silk White

pg. 24



Aura2 Prime
Pearl White

pg. 45

Featured: Jura Designer White Marble | Pg no. 51

SCANDINAVIAN DECOR





SILENTPRO FANS

The SilentPro range, with all new aesthetics and aerodynamic ABS body is designed to deliver Superior Air Comfort with reduced noise levels. SilentPro fans are 2X more Silent* than regular fans and are powered by the highly Energy Efficient ActivBLDC motor.



NEW



Scan the fan image to bring it to life
Here's how: goo.gl/Lens



ENSO

- Aerodynamic ABS body
- High Air Delivery
- Easy to clean - Anti-dust fan (in select models)
- 50% Savings on electricity costs
- Works with Point Anywhere Smart Remote
- Also available with IOT - Mobile App function (in select models)

Room Area (sq.ft)	Sweep (mm)	Power Inputs (Watts)	Speed (RPM)	Air Delivery (CMM)
156	1225	42	315	240

Room Type - Bedroom. Living Room.

EXPERIENCE SILENCE AND COMFORT



Silent, yet Powerful.

The SilentPro Enso, with its all new aesthetics is designed to deliver high air delivery with reduced noise levels. The Aerodynamic design of the ABS body reduces the air friction, thereby increasing the number of rotations per minute and assuring high performance in silence.



Experience Comfort.

At an air delivery of 240 CMM, SilentPro Enso delivers air comfort that rivals the best of the conventional fans available in the market. The fluidic seamless design of the blades is modelled to ensure high air delivery - delivering comfort to you when you need it.

2X MORE SILENT AT 52 dB**

Decibels Noise levels in dB	10 dB	30 dB	50 dB	70 dB	90 dB
Reference	Normal Breathing	Soft Whisper	A Quiet Home	Loud Conversation	Hand Blender

POINT ANYWHERE SMART REMOTE

No need to point at the fan to operate like ordinary remotes

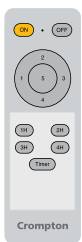

MULTI-PAIRING REMOTE FUNCTION



INTELLIGENT MEMORY FUNCTION



SLEEP WELL TIMER FUNCTION

ACTIVBLDC

HEART OF HIGH PERFORMANCE TECHNOLOGY



What makes Crompton ActivBLDC Superior?



High Power Factor of 0.98 for 98% effective energy utilization



90V - 300V Wide Voltage Range



5 Year Warranty

	Conventional Fan	Crompton SILENTPRO enso
Power Consumption	80 W	42 W
Hours of Usage per day	16	16
KWhr Units per day (Power X Hours / 1000)	1.28	0.67
Electricity Bill per day (₹) ₹ 6.5 / unit	8.32	4.36
Electricity Bill per annum (₹)	3,040	1,600
Annual Savings on 1 Fan		₹ 1,440 /-
Annual Savings on 4 Fans		₹ 5,760 /-

**Most regular ceiling fans operate at 64 dB. Every increase of 10 dB in noise level is perceived to be twice as loud. SilentPro operates at 52 dB level thereby making it twice more silent than its conventional counterparts. *Upto 50% Energy Saving as compared to a regular ceiling fan operating at the same RPM.

Colour Range



SMART

Option available with IOT-Mobile App

Silk White



SMART

Option available with IOT-Mobile App

All White



Chestnut Wood



Charcoal Grey



Mist White



Ballerina Pink



ENERGION FANS

Introducing Crompton's range of Energy Efficient fans powered by ActivBLDC motor technology that ensures up to 50% Electricity Savings* as compared to conventional fans.





Scan the fan image to bring it to life
Here's how: [goo.gl/Lens](https://www.google.com/lens)

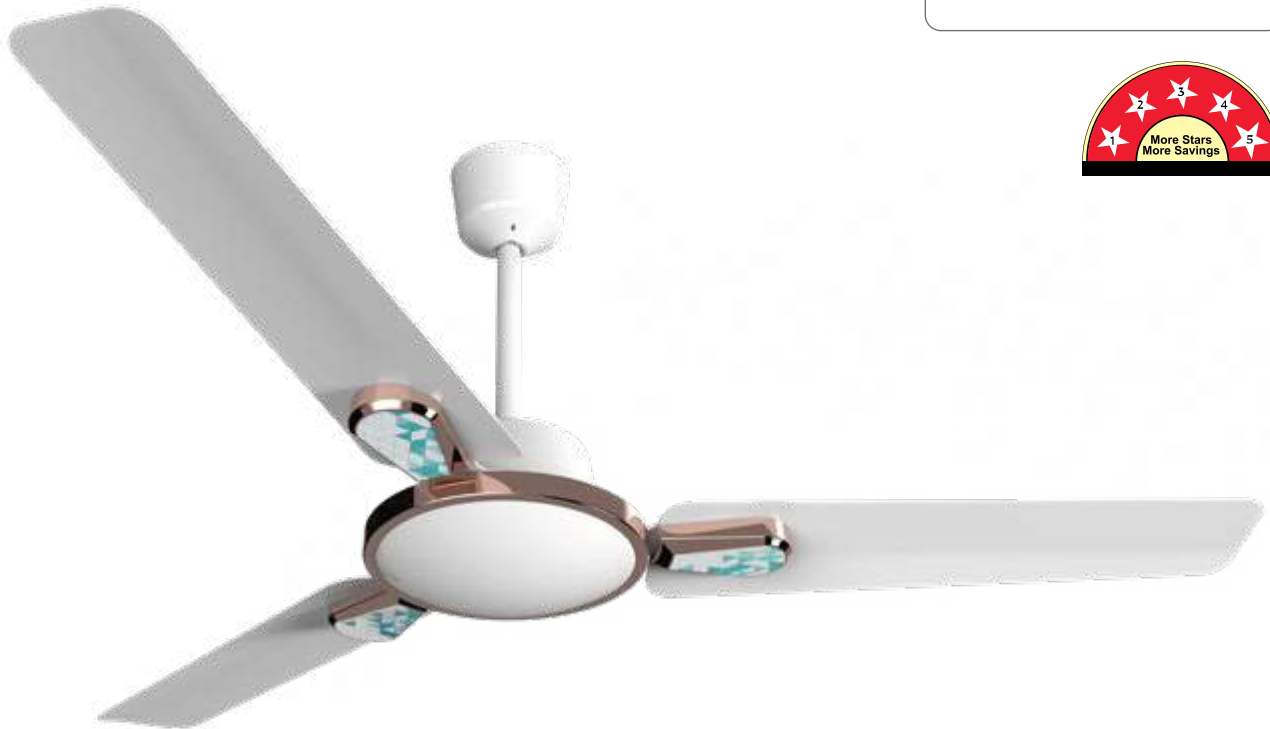

ENERGION FANS

SAVE UP TO
₹6000
EVERY YEAR

With Crompton's range of energy efficient fans
On an average use of 4 fans

What makes Crompton ActivBLDC Superior?



High Power Factor of 0.98 for 98% effective energy utilization



90V - 300V
Wide Voltage Range



5 Year Warranty

	Conventional Fan	ENERGION
Power Consumption	75 W	35 W
Hours of Usage per day	16	16
KWhr Units per day (Power X Hours / 1000)	1.2	0.56
Electricity Bill per day (₹) ₹ 6.5 / unit	7.8	3.7
Electricity Bill per annum (₹)	2,850	1,350
Annual Savings on 1 Fan		₹ 1,500 /-
Annual Savings on 4 Fans		₹ 6,000 /-

*Considering 16 hours of usage/day at a rate of ₹ 6.5/unit for Energion.

NEW



Gloss Black



POINT ANYWHERE SMART REMOTE

-  MULTI-PAIRING REMOTE FUNCTION
-  INTELLIGENT MEMORY FUNCTION
-  SLEEP WELL TIMER FUNCTION

ENERGION

STYLUS

- BEE 5 STAR Rated fan
- 50% Savings on electricity costs
- Easy to clean - Anti-dust fan
- Point Anywhere Smart Remote
- Also available with IOT - Mobile App function









SMART

Option available with IOT-Mobile App

Room Area (sq.ft)	Sweep (mm)	Power Inputs (Watts)	Speed (RPM)	Air Delivery (CMM)	BEE Rating
156	1200	35	370	220	

Room Type - Living Room. Bedroom.

Colour Range



Toast Brown



Gloss White



Opal White



POINT ANYWHERE SMART REMOTE

-  MULTI-PAIRING REMOTE FUNCTION
-  INTELLIGENT MEMORY FUNCTION
-  SLEEP WELL TIMER FUNCTION

HS

- BEE 5 STAR Rated fan
- 50% Savings on electricity costs
- Point Anywhere Smart Remote



Room Area (sq.ft)	Sweep (mm)	Power Inputs (Watts)	Speed (RPM)	Air Delivery (CMM)	BEE Rating
156	1200	35	370	220	

Room Type - Living Room. Bedroom.

Colour Range



Ivory



Brown

NEW



SMART REMOTE

INTELLIGENT MEMORY FUNCTION

SLEEP WELL TIMER FUNCTION



Brown

ENERGION

NSTAR



- BEE 5 STAR Rated fan
- 50% Savings on electricity costs
- Smart Remote

Room Area (sq.ft)	Sweep (mm)	Power Inputs (Watts)	Speed (RPM)	Air Delivery (CMM)	BEE Rating
156	1200	35	350	220	

Room Type - Living Room. Bedroom.

Colour Range



Ivory



White

LUXIAN FANS

Crompton's Lifestyle range of fans with Royal décor with Underlight options that offer opulent comfort





Black Chrome

URANUS

- Magnificent carvings for a royal décor.
- Decorative lampshades to enhance beauty.
- Convenient pull cord for speed and light control.

Room Area (sq.ft)	Sweep (mm)	Power Inputs (Watts)	Speed (RPM)	Air Delivery (CMM)
156	1200	72	320	200

Room Type - Living Room. Bedroom.

Colour Range



Ivory



Brass

JUPITER

- Magnificent carvings for a royal décor.
- Decorative lampshades to enhance beauty.
- Convenient pull cord for speed and light control.

Room Area (sq.ft)	Sweep (mm)	Power Inputs (Watts)	Speed (RPM)	Air Delivery (CMM)
156	1200	75	300	210

Room Type - Living Room. Bedroom.



Antique Brass

NEBULA

- Magnificent carvings for a royal décor.
- Decorative lampshades to enhance beauty.
- Convenient pull cord for speed and light control.

Room Area (sq.ft)	Sweep (mm)	Power Inputs (Watts)	Speed (RPM)	Air Delivery (CMM)
156	1200	72	320	200

Room Type - Living Room. Bedroom.



Antique Brass

TRITON ELECTROPLATED

- Contemporary design to complement modern décor
- Electroplated finish for superior aesthetics.
- Aerodynamically designed blades for high speed and air delivery.

Room Area (sq.ft)	Sweep (mm)	Power Inputs (Watts)	Speed (RPM)	Air Delivery (CMM)
156	1200	70	350	210

Room Type - Living Room. Bedroom.

Colour Range



Brushed Steel



Antique Copper



PREMION FANS

Spruce up your interiors with
Crompton's Premium & Designer
range of fans





AURA2

Aura2 comes with a 5 year warranty powered by Duratech technology. Duratech uses premium components, designed to deliver a superlative performance over the years.

Here's a quick look at the five key components that form the core of the Duratech technology.

Duratech comprises of:



High Endurance Box Capacitor

Aura's high-endurance box capacitor, with a patented adapter, ensures superior performance over a longer period as compared to ordinary oil-filled tube-type capacitors.



2 - Piece Construction

Unlike ordinary fans, which use a 3-piece construction, the 2-piece construction of our fans makes them robust, and less prone to vibration and noise. The construction also gives the fan a pleasing appearance, since there is no visible gap between the top and bottom motor-housing segments.



High Grade EMQ Bearing

EMQ bearings used for the Aura motor are the highest-grade bearings available for fans. They are silent and smooth, and have the additional advantage of reduced friction and vibration.



Dual Coat Copper

Dual-coat copper, used in motor windings, offers double protection, ensuring better insulation and abrasion resistance when subjected to high temperatures and sudden overloads. This results in longer durability as compared to ordinary copper wire.



High Standard CRNGO Steel

Aura fans use cold-rolled non-grain-oriented steel (CRNGO), which is highly compatible with electric motors. The composition and the thickness of the steel ensures fan durability and efficiency.



Birken Effect

Lotus Design



AURA2 DESIGNER 3D

- Elegant design to compliment modern décor
- Broad blade design for Higher Air Delivery
- High Speed

Room Area (sq.ft)	Sweep (mm)	Power Inputs (Watts)	Speed (RPM)	Air Delivery (CMM)
156	1200	74	380	230

Room Type - Living Room. Bedroom.

Colour Range



Pearl White



Bakers Brown

Brocade Design

AURA2 DESIGNER 2D



- Elegant design to compliment modern décor
- Broad blade design for Higher Air Delivery
- High Speed

Room Area (sq.ft)	Sweep (mm)	Power Inputs (Watts)	Speed (RPM)	Air Delivery (CMM)
156	1200	74	380	230

Room Type - Living Room. Bedroom.

Colour Range



Birken Effect



Rose Gold



Pearl White

Arab Design



AURA2 DESIGNER 2D

- Elegant design to compliment modern décor
- Broad blade design for Higher Air Delivery
- High Speed

Room Area (sq.ft)	Sweep (mm)	Power Inputs (Watts)	Speed (RPM)	Air Delivery (CMM)
156	1200	74	380	230

Room Type - Living Room. Bedroom.

Colour Range



Titanium



Rose Gold

AURA2 PRIME

- Elegant design to compliment modern décor
- Broad blade design for Higher Air Delivery
- High Speed



Room Area (sq.ft)	Sweep (mm)	Power Inputs (Watts)	Speed (RPM)	Air Delivery (CMM)
156	1200	74	380	230

Room Type - Living Room. Bedroom.

Colour Range



Starrynight Blue



Titanium



Pearl White Titanium



Pearl White



Phalsa Red



Bakers Brown



Dusky Brown



Birken Effect



Birken Effect Brown

PREMIUM



Titanium Effect

AURA PRIME



- Contemporary design with decorative trims
- Broad blade design for Higher Air Delivery
- High Speed

Room Area (sq.ft)	Sweep (mm)	Power Inputs (Watts)	Speed (RPM)	Air Delivery (CMM)
50	600	65	875	120
70	900	62	410	155
100	1050	65	360	190
156	1200	74	380	230
224	1400	84	285	270

Room Type - Powder Room. Kitchen. Bedroom. Living Room.

INDIA'S FIRST ANTI-DUST FAN

Colour Range



Birken Effect



Husky Gold



Butter Scotch



Onyx



Chicory



Lagoon Blue



Dusky Brown



Lilac Matt



Himalayan Grey



Lilac Gloss

PREMION

* 600 mm, 900 mm and 1050 mm sweeps are available in Birken Effect, Onyx and Chicory.



Cocoa Gold

AVANCER PRIME



- Unique angular motor design to spruce up your interiors.
- Broad blade design for Higher Air Delivery
- High Speed

Room Area (sq.ft)	Sweep (mm)	Power Inputs (Watts)	Speed (RPM)	Air Delivery (CMM)
70	900	56	420	155
100	1050	68	390	195
156	1200	77	370	230
224	1400	84	285	270

Room Type - Kitchen. Bedroom. Living Room.

INDIA'S FIRST ANTI-DUST FAN

Colour Range



Conch Cream



Lilac Matt



Bakers Brown



Roast Brown



Coffee Brown



Silky Silver



Indigo Blue



Lagoon Blue

PREMION

*900 and 1400 sweeps are available only in Cocoa Gold, Bakers Brown and Conch Cream

*1050 sweep available only in Cocoa Gold and Conch Cream



Caramel



DIGNITA

- Unique dual tone deco trims
- High speed

Room Area (sq.ft)	Sweep (mm)	Power Inputs (Watts)	Speed (RPM)	Air Delivery (CMM)
156	1200	77	370	225

Room Type - Living Room. Bedroom.

Colour Range



Roseberry



Snow Onyx



Marble Brown

PREMION



JURA DESIGNER

- The unmatched beauty of marble texture
- Wider blades for higher air delivery
- High Speed

Room Area (sq.ft)	Sweep (mm)	Power Inputs (Watts)	Speed (RPM)	Air Delivery (CMM)
156	1200	74	380	230

Room Type - Living Room, Bedroom.

Colour Range



Chalk White



HIGHSPEED FANS

Elegant designs to enhance your décor, offering superior air delivery for maximum comfort





Ivory

Colour Range



Brown

AURA



- Contemporary design to compliment modern décor
- Broad and aerodynamically designed blades for high air delivery
- 600, 900, 1400 sweeps are available only in Ivory
- Also available in New White

Room Area (sq.ft)	Sweep (mm)	Power Inputs (Watts)	Speed (RPM)	Air Delivery (CMM)
50	600	65	875	120
70	900	62	410	155
156	1200	74	380	230
224	1400	84	285	270

Room Type - Powder Room. Kitchen. Bedroom. Living Room.



Cool Grey

Colour Range



Olive Green



Roast Brown



Maroon Matt



SENOPRIME

- Aesthetically superior deco trims
- Innovative designer fan blade

Room Area (sq.ft)	Sweep (mm)	Power Inputs (Watts)	Speed (RPM)	Air Delivery (CMM)
70	900	60	420	160
156	1200	75	370	225

Room Type - Kitchen. Living Room. Bedroom.



Opal White



SENORITA

- Unique petal shaped blades to enhance aesthetics
- Attractive trims to complement modern décor

Room Area (sq.ft)	Sweep (mm)	Power Inputs (Watts)	Speed (RPM)	Air Delivery (CMM)
70	900	60	420	160
156	1200	75	370	225

Room Type - Kitchen. Living Room. Bedroom.



Conch Cream

Colour Range



Bakers Brown



Pearl Silver White

JURA PRIME

- Simple, yet elegant fan with Anti-dust properties
- Preferred choice of Interior designers
- Matt satin finish
- 600, 900 and 1050 mm available in Conch Cream



Room Area (sq.ft)	Sweep (mm)	Power Inputs (Watts)	Speed (RPM)	Air Delivery (CMM)
156	1200	74	380	230

Room Type - Living Room. Bedroom.



Bakers Brown

Colour Range



Opal White

Pearl Ivory

Pearl Silver White



JURA

- Simple, yet elegant fan with Anti-dust properties
- Preferred choice of Interior designers
- 600, 900 and 1050 mm sweeps are available only in Pearl Silver White and Bakers Brown
- 1400 mm sweep is available only in Bakers Brown

Room Area (sq.ft)	Sweep (mm)	Power Inputs (Watts)	Speed (RPM)	Air Delivery (CMM)
50	600	65	875	120
70	900	62	410	155
100	1050	65	360	190
156	1200	74	380	230
224	1400	84	285	270

Room Type - Powder Room. Kitchen. Bedroom. Living Room.



Roast Brown



DEVINE

- Decorative motor and designer blades to complement modern décor
- Unique petal shaped blades to enhance aesthetics

Room Area (sq.ft)	Sweep (mm)	Power Inputs (Watts)	Speed (RPM)	Air Delivery (CMM)
156	1200	76	370	225

Room Type - Living Room. Bedroom.

NEW



Ivory

DIEGO



- Metallic finish with Anti-corrosive blade & body
- Wider blades for higher air delivery

Room Area (sq.ft)	Sweep (mm)	Power Inputs (Watts)	Speed (RPM)	Air Delivery (CMM)
156	1200	72	380	210

Room Type - Living Room. Bedroom.

HIGHSPEED

Colour Range



Opal White



Smoked Brown



Matte Black

NEW



Roast Brown



GIANNA

- Decorative motor design
- Metallic finish with Anti-corrosive blade & body
- Wider blades for higher air delivery

Room Area (sq.ft)	Sweep (mm)	Power Inputs (Watts)	Speed (RPM)	Air Delivery (CMM)
156	1200	75	380	220

Room Type - Living Room. Bedroom.

Colour Range



Pearl White



Rose Ash



Tapioca



Walnut Brown

NEW



Pearl White



HIGHSPEED

MODERN LEAF

- Unique motor design with dual tone trims
- Metallic finish with Anti-corrosive blade & body
- Wider blades for higher air delivery

Room Area (sq.ft)	Sweep (mm)	Power Inputs (Watts)	Speed (RPM)	Air Delivery (CMM)
156	1200	72	390	220

Room Type - Living Room. Bedroom.

Colour Range



NEW



Red Velvet

MARKLE PRIME



- A decorative design masterpiece to add to the element of décor to your home
- Aesthetically superior motor design with deco ring
- Unique shimmering shadow effect on trims

Room Area (sq.ft)	Sweep (mm)	Power Inputs (Watts)	Speed (RPM)	Air Delivery (CMM)
156	1200	55	370	225

Room Type - Living Room. Bedroom.

Colour Range



Pearl White



Burgundy

NEW



Orange Rust

MARKLE DESIGNER



- A decorative design masterpiece to add to the element of décor to your home
- Aesthetically superior motor design with deco ring
- Unique holographic royal effect on trims

Room Area (sq.ft)	Sweep (mm)	Power Inputs (Watts)	Speed (RPM)	Air Delivery (CMM)
156	1200	55	370	225

Room Type - Living Room. Bedroom.

HIGHSPEED

Colour Range



Vanilla Sky



Navy

NEW



Berry Blast



BRUNA

- An aesthetic design with contemporary finish to give a modern appeal
- Unique dual tone pebble trims design

Room Area (sq.ft)	Sweep (mm)	Power Inputs (Watts)	Speed (RPM)	Air Delivery (CMM)
156	1200	72	380	230

Room Type - Living Room. Bedroom.

Colour Range



Glow White



Powder Blue

NEW

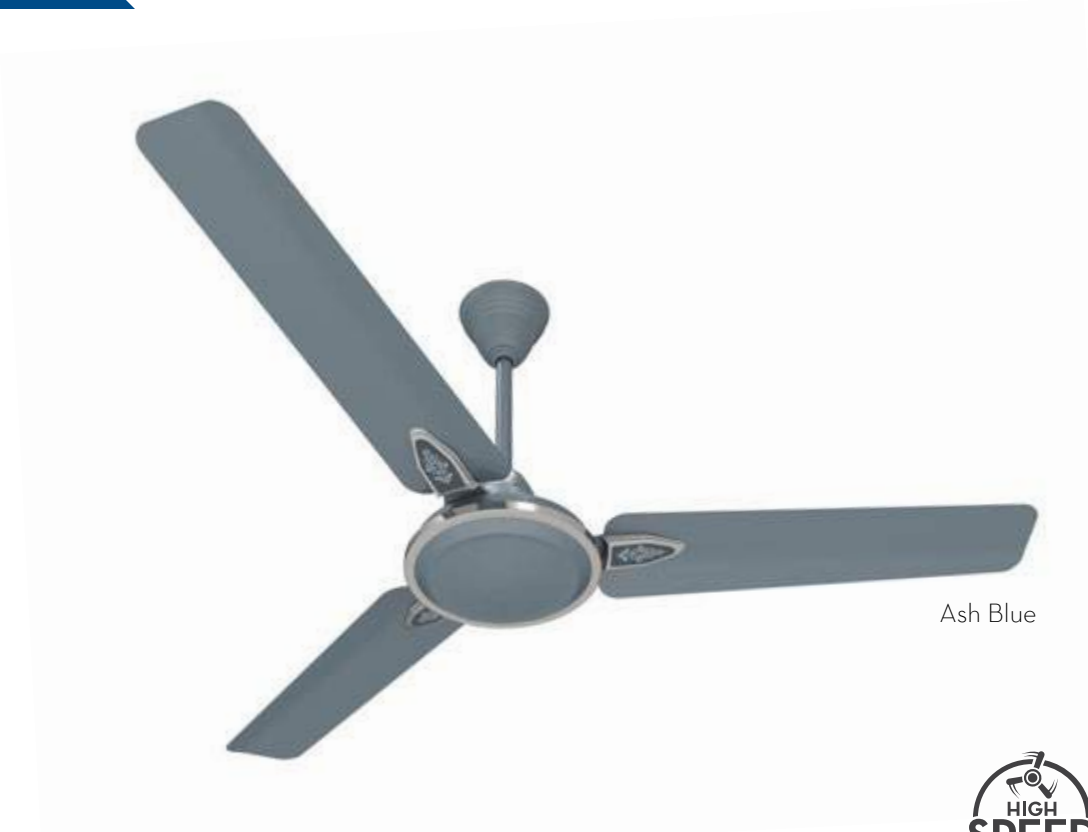

Ash Blue



RUBIO

- An aesthetic design with contemporary finish to give a modern appeal
- Motor design with deco ring with designer trims

Room Area (sq.ft)	Sweep (mm)	Power Inputs (Watts)	Speed (RPM)	Air Delivery (CMM)
156	1200	72	380	230

Room Type - Living Room. Bedroom.

HIGHSPEED

Colour Range



Glow White



Red Wine



Warm Grey



Golden Brown

Colour Range



Maroon Ivory



Silver White



SPLITZ

- Exotic blade trims & body ring

Room Area (sq.ft)	Sweep (mm)	Power Inputs (Watts)	Speed (RPM)	Air Delivery (CMM)
156	1200	77	370	225

Room Type - Living Room. Bedroom.



Ginger Gold

Colour Range



Bakers Brown



Aqua Gold



Lavender



HS DECORA METALLIC

- Aerodynamically designed blades for high speed and air delivery
- Superior metallic colour options to enhance décor
- Gold ring on canopies

Room Area (sq.ft)	Sweep (mm)	Power Inputs (Watts)	Speed (RPM)	Air Delivery (CMM)
156	1200	70	370	230

Room Type - Living Room. Bedroom.



Brown

Colour Range



Ivory



HS DECORA

- Ornamental design with gold finish shanks on motor & blades
- Gold ring on canopies

Room Area (sq.ft)	Sweep (mm)	Power Inputs (Watts)	Speed (RPM)	Air Delivery (CMM)
156	1200	70	370	230
224	1400	80	280	270

Room Type - Living Room. Bedroom.



Opal White

Colour Range



Brown



Ivory

HS PLUS

- BEE Star rated fan
- Power saving fan
- National Energy Conservation Award for Energy efficient fan from BEE

Room Area (sq.ft)	Sweep (mm)	Power Inputs (Watts)	Speed (RPM)	Air Delivery (CMM)
156	1200	53	370	218

Room Type - Living Room. Bedroom.





Brown



HS

- Unique gold line on motor
- 600, 900, 1050, 1400 mm sweeps are available only in Opal White, Brown and Ivory.

Room Area (sq.ft)	Sweep (mm)	Power Inputs (Watts)	Speed (RPM)	Air Delivery (CMM)
50	600	64	900	120
70	900	60	390	155
100	1050	66	370	195
156	1200	70	370	230
224	1400	80	280	270

Room Type - Powder Room. Kitchen. Bedroom. Living Room.

Colour Range



Ivory



Opal White



Bianco



RIVIERA

- Simplicity in motor design
- Standard model with good performance
- Bianco colour available in 1200 sweep only
- Also available in Opal White

Room Area (sq.ft)	Sweep (mm)	Power Inputs (Watts)	Speed (RPM)	Air Delivery (CMM)
70	900	60	390	155
100	1050	66	370	195
156	1200	72	380	230
224	1400	85	270	260

Room Type - Kitchen. Bedroom. Living Room.

HIGHSPEED

Colour Range



Brown



SUREBREEZE FANS

Assured performance with 100%
copper winding and double ball
bearing





Smoked Brown

Colour Range



Birken Ivory

Silver White

Birken White



SUPER BRIZ DECO

- Decorative trims on motors and blades
- Silver White available only in 1200 mm sweep

Room Area (sq.ft)	Sweep (mm)	Power Inputs (Watts)	Speed (RPM)	Air Delivery (CMM)
70	900	60	420	140
156	1200	70	400	210
224	1400	80	300	245

Room Type - Kitchen. Bedroom. Living Room.



Smoked Brown

Colour Range



Birken Ivory

Silver White

Birken White



SUPER AIR DECO

- Decorative trims on motors and blades

Room Area (sq.ft)	Sweep (mm)	Power Inputs (Watts)	Speed (RPM)	Air Delivery (CMM)
156	1200	70	400	210

Room Type - Living Room. Bedroom.



Coral Gold

Colour Range



Mink Brown

ARIYA BRIZ PRIME

- Unique colour options with metallic finish
- Anti-rust aluminium body and blade
- Also available in 600 mm



Room Area (sq.ft)	Sweep (mm)	Power Inputs (Watts)	Speed (RPM)	Air Delivery (CMM)
156	1200	70	370	200

Room Type - Living Room. Bedroom.



Brown

Colour Range



Opal White



Lustre Brown



Ivory

ARIYA BRIZ

- Attractive gold ring on motor
- Anti-rust aluminium body and blade



Room Area (sq.ft)	Sweep (mm)	Power Inputs (Watts)	Speed (RPM)	Air Delivery (CMM)
50	600	64	850	120
156	1200	68	380	210

Room Type - Powder Room. Living Room. Bedroom.



Lustre Brown

Colour Range



Ivory

COOL BREEZE DECO

- Decorative motor design and shanks
- Anti-rust aluminium body and blade



Room Area (sq.ft)	Sweep (mm)	Power Inputs (Watts)	Speed (RPM)	Air Delivery (CMM)
156	1200	75	380	210

Room Type - Living Room. Bedroom.



Lustre Brown

Colour Range



Ivory



Opal White

COOL BREEZE

- Attractive gold ring on motor
- Anti-rust aluminium body and blade
- 900 mm sweep is available only in opal white
- 1400 mm sweep is available only in opal white



Room Area (sq.ft)	Sweep (mm)	Power Inputs (Watts)	Speed (RPM)	Air Delivery (CMM)
50	600	55	860	110
70	900	65	460	135
100	1050	70	420	165
156	1200	75	380	210
224	1400	82	290	245

Room Type - Powder Room. Kitchen. Bedroom. Living Room.



Opal White



SAFE AIR

- Safety cable provided for additional safety
- Anti-rust aluminium body and blade
- Also available in Brown & Ivory

Room Area (sq.ft)	Sweep (mm)	Power Inputs (Watts)	Speed (RPM)	Air Delivery (CMM)
156	1200	75	380	205

Room Type - Living Room. Bedroom.



Brown

Colour Range



Ivory

Opal White



BRIZ AIR

- Anti-rust aluminium body and blade
- 1400 mm sweep is available only in Opal White

Room Area (sq.ft)	Sweep (mm)	Power Inputs (Watts)	Speed (RPM)	Air Delivery (CMM)
50	600	62	850	115
70	900	60	415	145
100	1050	68	370	180
156	1200	75	380	205
224	1400	75	290	245

Room Type - Powder Room. Kitchen. Bedroom. Living Room.



Lustre Brown

Colour Range



Ivory

Opal White



SEA WIND

- Attractive gold ring on motor

Room Area (sq.ft)	Sweep (mm)	Power Inputs (Watts)	Speed (RPM)	Air Delivery (CMM)
156	1200	70	380	200

Room Type - Living Room. Bedroom.



Lustre Brown

Colour Range



Ivory

Opal White



SEA BREEZE

- Attractive gold ring on motor

Room Area (sq.ft)	Sweep (mm)	Power Inputs (Watts)	Speed (RPM)	Air Delivery (CMM)
156	1200	70	380	200

Room Type - Living Room. Bedroom.



Brown

Colour Range



Opal White



ALPHA BRIZ

- Attractive gold ring on motor
- Also available in Ivory.

Room Area (sq.ft)	Sweep (mm)	Power Inputs (Watts)	Speed (RPM)	Air Delivery (CMM)
156	1200	75	380	205

Room Type - Living Room. Bedroom.



Brown

Colour Range



Ivory



Opal White



NEO BREEZE

- Attractive gold ring on motor

Room Area (sq.ft)	Sweep (mm)	Power Inputs (Watts)	Speed (RPM)	Air Delivery (CMM)
156	1200	75	380	205

Room Type - Living Room. Bedroom.



Opal White



SEA BLISS

- Attractive gold ring on motor
- High Speed of 400 RPM
- Also available in Brown & Ivory

Room Area (sq.ft)	Sweep (mm)	Power Inputs (Watts)	Speed (RPM)	Air Delivery (CMM)
156	1200	65	400	200

Room Type - Living Room. Bedroom.



Opal White



STAR 220

- BEE Star rated fan
- National Energy Conservation Award for Energy efficient fan from BEE

Room Area (sq.ft)	Sweep (mm)	Power Inputs (Watts)	Speed (RPM)	Air Delivery (CMM)
156	1200	50	360	220

Room Type - Living Room. Bedroom.



Opal White



ENTRUST 50

- BEE Star rated fan
- National Energy Conservation Award for Energy efficient fan from BEE

Room Area (sq.ft)	Sweep (mm)	Power Inputs (Watts)	Speed (RPM)	Air Delivery (CMM)
156	1200	50	370	215

Room Type - Living Room. Bedroom.



Opal White



EMPOWER 50

- BEE Star rated fan
- National Energy Conservation Award for Energy efficient fan from BEE

Room Area (sq.ft)	Sweep (mm)	Power Inputs (Watts)	Speed (RPM)	Air Delivery (CMM)
156	1200	50	370	210

Room Type - Living Room. Bedroom.



Lustre Brown

WWPS

- Energy saving fan



Room Area (sq.ft)	Sweep (mm)	Power Inputs (Watts)	Speed (RPM)	Air Delivery (CMM)
156	1200	50	310	200

Room Type - Living Room, Bedroom.

Colour Range



Opal White



Lustre Brown

WWHE



- Energy saving fan

Room Area (sq.ft)	Sweep (mm)	Power Inputs (Watts)	Speed (RPM)	Air Delivery (CMM)
156	1200	50	310	200
224	1400	60	290	245

Room Type - Living Room. Bedroom.

Colour Range



Opal White





TABLE PEDESTAL WALL FANS

Sleek and Sturdy designs with Superior Air delivery delivering maximum comfort to you when you need it.



NEW



White



HIGH FLO WAVE PLUS

- Superior Air Delivery
- Improved blade design
- Thermal overload protection
- Sturdy construction

Sweep (mm)	Power Inputs (Watts)	Speed (RPM)	Air Delivery (CMM)
400	60	1350	85



Crimson Red

Colour Range



White



Coffee



Blue



HIGH FLO NEO

- PP blade, low noise operation
- Thermal overload protection for long lasting motor
- Smooth oscillation, elegant aesthetic

Sweep (mm)	Power Inputs (Watts)	Speed (RPM)	Air Delivery (CMM)
400	58	1330	85

NEW



KD White



HIGHSPEED TORPEDO

- Powerful High Speed motor
- Range of unique colours
- Thermal overload protection
- Sturdy construction
- Elegant colour options - Also available in Black, Black Yellow, Blue White

Sweep (mm)	Power Inputs (Watts)	Speed (RPM)	Air Delivery (CMM)
400	125	2100	105



Red Black

Colour Range



Black



Red White



WHIRLWIND GALE

- High Speed. Best-in-class Air Delivery.
- Wide oscillation with motorised control. Smooth neck tilting. Switch operated oscillation
- Strong base for stability. ABS Blades.
- Thermal overload protection. Finger proof grill.
- * Also available in White.

Sweep (mm)	Power Inputs (Watts)	Speed (RPM)	Air Delivery (CMM)
400	120	2100	120



Pastel Green

Colour Range



Pastel Orange



SILENTPRO PENTAFLO

- Provides higher air delivery than conventional fans.
- Silent operation
- Wide oscillation with motorised control. Smooth neck tilting.
- Strong base for stability. ABS Blade stand.
- Thermal overload protection. Finger proof grill.
- Elegant colour options

Sweep (mm)	Power Inputs (Watts)	Speed (RPM)	Air Delivery (CMM)
400	62	1350	85



Black Gold



Black

Colour Range



Ash Grey

SDX BLACK GOLD

- Black metal stand & guard, golden colour metal blades

Sweep (mm)	Power Inputs (Watts)	Speed (RPM)	Air Delivery (CMM)
400	54	1360	77

WINDMILL

- Unique Windmill like Blade for high performance
- Thermal overload protection for long lasting motor

Sweep (mm)	Power Inputs (Watts)	Speed (RPM)	Air Delivery (CMM)
400	54	1360	77

NEW



White

HIGH FLO WAVE PLUS

- PP blade low noise operation
- Thermal overload protection for long lasting motor
- Smooth oscillation, elegant aesthetic



Sweep (mm)	Power Inputs (Watts)	Speed (RPM)	Air Delivery (CMM)
400	60	1350	85

TPW



Coffee

Colour Range



Blue



Red



White

HIGH FLO NEO



- PP blade, low noise operation
- Thermal overload protection for long lasting motor
- Smooth oscillation, elegant aesthetic

Sweep (mm)	Power Inputs (Watts)	Speed (RPM)	Air Delivery (CMM)
400	58	1330	85

NEW



KD White



HIGHSPEED TORPEDO

- Powerful High Speed motor
- Range of unique colours
- Thermal overload protection
- Sturdy construction
- Elegant colour options - Also available in Black, Black Yellow, Blue White

Sweep (mm)	Power Inputs (Watts)	Speed (RPM)	Air Delivery (CMM)
400	125	2100	105

TPW



Red Black

Colour Range



White



Black



Red White

WHIRLWIND GALE



- High Speed. Best-in-class Air Delivery.
- Wide oscillation with motorised control. Smooth neck tilting. Switch operated oscillation
- Strong base for stability. ABS Blades.
- Thermal overload protection. Finger proof grill.

Sweep (mm)	Power Inputs (Watts)	Speed (RPM)	Air Delivery (CMM)
400	120	2100	120



Pastel Orange

Colour Range



KD - White



Pastel Green



Ink - Blue

SILENTPRO PENTAFLO



- Provides Higher Air Delivery than conventional fans.
- Silent operation
- Wide oscillation with motorised control. Smooth neck tilting.
- Strong base for stability. ABS Blade stand.
- Thermal overload protection. Finger proof grill.
- Elegant colour options

Sweep (mm)	Power Inputs (Watts)	Speed (RPM)	Air Delivery (CMM)
400	62	1350	85



White

Colour Range



Wine Red



Grey

WIND FLO

- High Speed Fan
- Elegant looks
- Wide oscillation with control



Sweep (mm)	Power Inputs (Watts)	Speed (RPM)	Air Delivery (CMM)
400	110	2000	85



Chrome
Black

WINDMILL

- Metallic sturdy construction
- Thermal overload protection for long lasting motor
- Elegant colour

Sweep (mm)	Power Inputs (Watts)	Speed (RPM)	Air Delivery (CMM)
400	54	1360	77



Black Gold

SDX BLACK GOLD

- Metallic sturdy construction, thermal overload protection for long lasting motor
- Royal colour

Sweep (mm)	Power Inputs (Watts)	Speed (RPM)	Air Delivery (CMM)
400	54	1360	77



Silver Black

SSTORM 2

- High Air Delivery with low noise operation
- Thermal protection for long lasting motor
- Royal finish
- Smooth oscillation



Sweep (mm)	Power Inputs (Watts)	Speed (RPM)	Air Delivery (CMM)
450	90	1350	100



Black

SUREBREEZE GLADIATOR



- High Performance - provides higher Air Delivery than conventional fans
- Silent operation
- User friendly - Wide oscillation with motorised control. Smooth neck tilting
- Durable construction - Sturdy base for stability. Aluminium blades for durability
- Safe - Thermal overload protection. Finger proof grill.

Sweep (mm)	Power Inputs (Watts)	Speed (RPM)	Air Delivery (CMM)
400	65	1330	90



Dark Grey



White Grey

BRIZSTAR FARRATA



- Sturdy metallic base
- Anti-rust aluminium blades

Sweep (mm)	Power Inputs (Watts)	Speed (RPM)	Air Delivery (CMH)
500	145	1400	7500

WINDSTAR FARRATA



- Sturdy metallic base
- Anti-rust aluminium blades

Sweep (mm)	Power Inputs (Watts)	Speed (RPM)	Air Delivery (CMH)
500	160	1330	6800

NEW



White



HIGH FLO WAVE PLUS

- Superior Air Delivery
- Improved blade design
- Thermal overload protection
- Sturdy construction

Sweep (mm)	Power Inputs (Watts)	Speed (RPM)	Air Delivery (CMM)
400	60	1350	85



Blue

Colour Range



White



Coffee



Red



HIGH FLO NEO

- PP blade, low noise operation
- Thermal overload protection for long lasting motor
- Smooth oscillation, elegant aesthetic

Sweep (mm)	Power Inputs (Watts)	Speed (RPM)	Air Delivery (CMM)
400	58	1330	85

NEW



KD White



HIGHSPEED TORPEDO

- Powerful High Speed motor
- Range of unique colours
- Thermal overload protection
- Sturdy construction
- Elegant colour options - Also available in Black, Black Yellow, Blue White

Sweep (mm)	Power Inputs (Watts)	Speed (RPM)	Air Delivery (CMM)
400	125	2100	105



Red Black

Colour Range



Red White



Black



White



WHIRLWIND GALE

- High Speed. Best-in-class Air Delivery.
- Wide oscillation with motorised control. Smooth neck tilting. Switch operated oscillation
- Strong base for stability. ABS Blades.
- Thermal overload protection. Finger proof grill.

Sweep (mm)	Power Inputs (Watts)	Speed (RPM)	Air Delivery (CMM)
400	120	2100	120
300	90	2100	65



Pastel Green

Colour Range



Pastel Orange



SILENTPRO PENTAFLO

- Provides Higher Air Delivery than conventional fans.
- Silent operation
- Wide oscillation with motorised control. Smooth neck tilting.
- Strong base for stability. ABS Blade stand.
- Thermal overload protection. Finger proof grill.
- Elegant colour options.

Sweep (mm)	Power Inputs (Watts)	Speed (RPM)	Air Delivery (CMM)
400	62	1350	85



Blue



WIND FLO

- Elegant Looks
- Wide oscillation with control

Sweep (mm)	Power Inputs (Watts)	Speed (RPM)	Air Delivery (CMM)
300	80	2100	52
400	110	2000	85



Black Gold

SDX BLACK GOLD

- Metallic sturdy construction, thermal overload protection for long lasting motor
- Royal colour

Sweep (mm)	Power Inputs (Watts)	Speed (RPM)	Air Delivery (CMM)
400	54	1360	77



Silver Black

SSTORM 2

- High Air Delivery with Low noise operation
- Thermal protection for long lasting motor
- Royal finish
- Smooth oscillation



Sweep (mm)	Power Inputs (Watts)	Speed (RPM)	Air Delivery (CMM)
450	90	1350	100



DOMESTIC EXHAUST FANS

Stylish Metallic and ABS body options
with powerful suction and low noise
operation





Grey

TRANSAIR / TRANSAIR REVERSIBLE

- With the flick of a switch one can opt for exhaust mode or fresh air mode in Transair Reversible.
- Bird screen for protection against bird & foreign matter.
- Reversible type available in 225mm & 300mm size only.

Sweep (mm)	Power Inputs (Watts)	Speed (RPM)	Air Delivery (CMH)
150	50	2000	320
225	45	1400	720
300	70	1380	1600

NEW



Grey



DRIFT AIR PLUS

- Sturdy Metal body with Metal blades.
- Metal bird screen for protection from birds and foreign matter.

* New variant available with Anti-dust coating

Sweep (mm)	Power Inputs (Watts)	Speed (RPM)	Air Delivery (CMH)
150	42	2300	400
225	38	1370	800
300	50	1350	1160



Grey

FLUX AIR

- Sturdy metal body with metal blades, corrosion resistant coating on blade and body.
- Plastic bird screen for protection from birds and foreign matter.

Sweep (mm)	Power Inputs (Watts)	Speed (RPM)	Air Delivery (CMH)
225	31	1380	800



White

Colour Range



Wood

NEW MOUNT AIR

- Lightweight and sleek design with ABS body
- Silent operation and superior air flow
- Can be installed on Glass, Wall and Ceiling
- Also available in Black, Ivory, Brown and Steel colours

Sweep (mm)	Power Inputs (Watts)	Speed (RPM)	Air Delivery (CMH)
100	14	2200	120
150	22	2000	200



White

Aerodynamic blades for faster speed

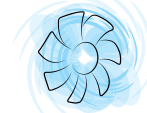

Powerful air suction for odourless and clean air

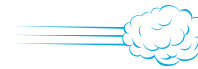

Automatic dust protection shutters for hassle-free hygiene

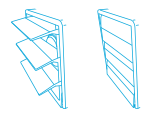

Light and rust proof body for durability



AXIAL AIR

- Sturdy front grill for additional safety
- Also available in Black, Brown, Ivory

Sweep (mm)	Power Inputs (Watts)	Speed (RPM)	Air Delivery (CMH)
100	12	2400	140
150	20	1750	275

NEW



White

Aerodynamic blades for faster speed



Powerful air suction for odourless and clean air

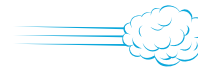

Light and rust proof body for durability



BRISK AIR NEO

- Sleek design with aerodynamic blades

Sweep (mm)	Power Inputs (Watts)	Speed (RPM)	Air Delivery (CMH)
150	25	1300	275
200	30	1300	450
250	40	1250	720



White

BRISK AIR PLUS

- Sleek design with aerodynamic blades

Sweep (mm)	Power Inputs (Watts)	Speed (RPM)	Air Delivery (CMH)
150	25	1300	275
200	30	1300	450
250	40	1250	720



White

Aerodynamic blades for faster speed



Powerful air suction for odourless and clean air

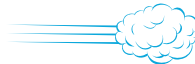

Automatic dust protection shutters for hassle-free hygiene

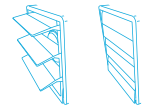

Light and rust proof body for durability



VENTILUS

- Automatic Shutter for dust protection.
- Also available in Ivory
- White available only in 10"

Sweep (mm)	Power Inputs (Watts)	Speed (RPM)	Air Delivery (CMH)
150	25	1300	275
200	30	1300	450
250	35	1300	900



INDUSTRIAL FANS

Heavy Duty fans with powerful motors and superior air delivery for industrial use

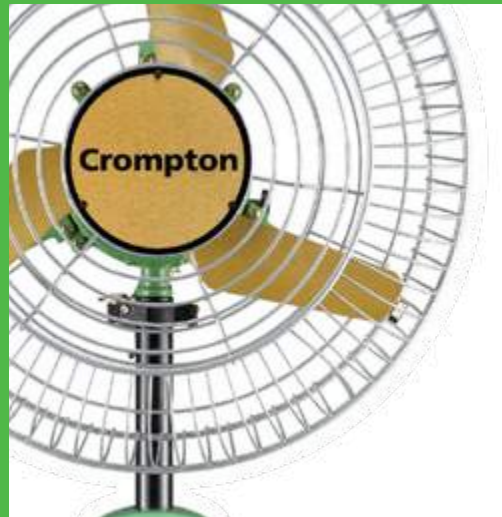



HEAVY DUTY EXHAUST FANS

- Totally enclosed, continuously rated highly efficient heavy-duty motor with pressure die cast aluminium rotor mounted on two ball bearings.
- Aerodynamically contoured blades handle maximum air with minimum power consumption.
- Rigid frame with rubber mountings for silent operations.
- Epoxy powder coating with specially pretreated components for better resistance to corrosion.
- Degree of protection against dust & water entry is IP55.

SPECIFICATIONS

Model Name	Impeller Diameter (mm)	Phase	Pole	Power Inputs (Watts)	Speed (RPM)	Air Delivery (CMH)	Current (AMP)	Noise Level (dBA)
EXHD300-4-1 (ISI)*	300	Single	4 Pole	90	1400	1710	0.43	56
EXHD300-6-1 (ISI)	300	Single	6 Pole	55	950	1145	0.26	54
EXHD380-4-1 (ISI)	380	Single	4 Pole	150	1400	3250	0.72	63
EXHD380-4-3	380	Three	4 Pole	150	1400	3250	0.30	63
EXHD380-6-1	380	Single	6 Pole	100	950	2000	0.48	56
EXHD450-4-1 (ISI)*	450	Single	4 Pole	350	1400	6120	1.98	65
EXHD450-4-3	450	Three	4 Pole	350	1400	6120	0.94	65
EXHD450-6-1	450	Single	6 Pole	145	950	3900	0.70	63
EXHD600-6-1	600	Single	6 Pole	550	950	9400	2.65	65
EXHD600-6-3	600	Three	6 Pole	550	950	9400	1.27	65
EXHD900-8-3	900	Three	8 Pole	1200	700	25200	2.60	68

* Also available in IP65 rating for Industries like Ceramic, Spice, Cement etc.



COOLER KIT

- Strong high performance motor
- Peak performance even at low voltages
- High quality electrical steel & copper wire for longer life

Sweep (mm)	Power Inputs (Watts)	Speed (RPM)	Air Delivery (CMH)
500	145	1370	3215

Specification of Submersible Pump

Model	Max Head	Power Inputs (Watts)	Recommended Cooler Height	Discharge (Litres/hr)
(STD)	5.5 ft	12	3 - 3.5 ft	500



Pedestal

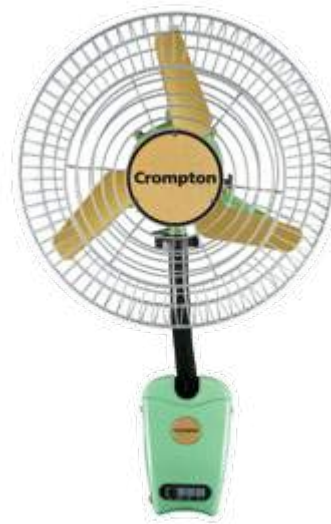

Wall

VORTEX SERIES (AIR CIRCULATORS)

- Aerodynamically designed blades for higher air delivery
- Heavy duty motor with double ball bearing for longer life
- Oscillation to 85° deg
- Heavy Base for greater stability
- Improved guard design
- Attractive aesthetic to suit your application
- Increase in RPM from 1400 to 1440

450 mm	600 mm	750 mm
Pedestal	Pedestal	Pedestal
Wall	Wall	Wall

Major Applications

- Railway Stations
- Airports
- Heat Treatment
- Pandal Decorators
- Factories
- Public Places

PERFORMANCE GUIDE

Product ID	Type	Sweep (mm)	Phase	Speed (RPM)	Capacitor (MFD)	Air Delivery (M ³ /H)	Current (AMP)	Power Input (Watts)	Noise Level (dba)	Adjustable height (M)
ACVORTEX18PF	Pedestal	450	Single	1440	3.15	7500	0.45	100	64	1.35 / 1.025
ACVORTEX18WM	Wall	450	Single	1440	3.15	7500	0.45	100	64	
ACVORTEX24PF	Pedestal	600	Single	1440	5	16000	0.95	200	68	1.75 / 1.325
ACVORTEX24WM	Wall	600	Single	1440	5	16000	0.95	200	68	
ACVORTEX30PF	Pedestal	750	Single	1440	5	22200	1.2	250	76	1.75 / 1.325
ACVORTEX30WM	Wall	750	Single	1440	5	22200	1.2	250	76	

* Rated Voltage 230v. 50Hz AC for single phase 415v. 50Hz for three Phase fans
 * Built in Regulator Available only for 450mm sweep

Dimensional Specifications

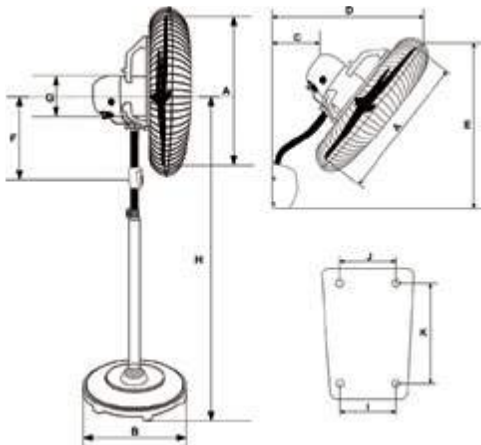

Model	A	B	H		E		C		D		F	G	I	J	K
			Mini	Max	Mini	Max	Mini	Max	Mini	Max					
VORTEX 450 mm PF	450	450	1135	1200							350	164			
VORTEX 600 mm PF	600	515	1290	1600								164			
VORTEX 750 mm PF	750	515	1290	1600								164			
VORTEX 450 mm WF	450				760	800	70	120	380	450		164	85	115	190
VORTEX 600 mm WF	600				830	870	120	160	530	580		164	85	115	190
VORTEX 750 mm WF	750				1100	1200	120	160	530	580		164	85	115	190

PRODUCT INDEX

Sweep Size - 100 mm

Sr. no	Category	Design Name	Power Inputs (Watts)	Speed (RPM)	Air Delivery (CMM)	Page no.
1	Domestic Exhaust	New Mount Air	14	2200	120	103
2	Domestic Exhaust	Axial Air	12	2400	140	104

Sweep Size - 150 mm

Sr. no	Category	Design Name	Power Inputs (Watts)	Speed (RPM)	Air Delivery (CMM)	Page no.
1	Domestic Exhaust	Transair	50	2000	320	102
2	Domestic Exhaust	Drift Air Plus	42	2300	400	102
3	Domestic Exhaust	New Mount Air	22	2000	200	103
4	Domestic Exhaust	Axial Air	20	1750	275	104
5	Domestic Exhaust	Brisk Air Neo	25	1300	275	104
6	Domestic Exhaust	Brisk Air Plus	25	1300	275	105
7	Domestic Exhaust	Ventilus	25	1300	275	105

Sweep Size - 200 mm

Sr. no	Category	Design Name	Power Inputs (Watts)	Speed (RPM)	Air Delivery (CMM)	Page no.
1	Domestic Exhaust	Brisk Air Neo	30	1300	450	104
2	Domestic Exhaust	Brisk Air Plus	30	1300	450	105
3	Domestic Exhaust	Ventilus	30	1300	450	105

Sweep Size - 225 mm

Sr. no	Category	Design Name	Power Inputs (Watts)	Speed (RPM)	Air Delivery (CMM)	Page no.
1	Domestic Exhaust	Transair	45	1400	720	102
2	Domestic Exhaust	Drift Air Plus	38	1370	800	102
3	Domestic Exhaust	Flux Air	31	1380	800	103

Sweep Size - 250 mm

Sr. no	Category	Design Name	Power Inputs (Watts)	Speed (RPM)	Air Delivery (CMM)	Page no.
1	Domestic Exhaust	Brisk Air Neo	40	1250	720	104
2	Domestic Exhaust	Brisk Air Plus	40	1250	720	105
3	Domestic Exhaust	Ventilus	35	1300	900	105

Sweep Size - 300 mm

Sr. no	Category	Design Name	Power Inputs (Watts)	Speed (RPM)	Air Delivery (CMM)	Page no.
1	TPW Wall Fans	Whirlwind Gale	90	2100	65	97
2	TPW Wall Fans	Wind Flo	80	2100	52	98
3	Domestic Exhaust	Transair	70	1380	1600	102
4	Domestic Exhaust	Drift Air Plus	50	1350	1160	102

Sweep Size - 400 mm

Sr. no	Category	Design Name	Power Inputs (Watts)	Speed (RPM)	Air Delivery (CMM)	Page no.
1	TPW Table Fans	High Flo Wave Plus	60	1350	85	82
2	TPW Table Fans	High Flo Neo	58	1330	85	82
3	TPW Table Fans	Highspeed Torpedo	125	2100	105	83
4	TPW Table Fans	Whirlwind Gale	120	2100	120	83
5	TPW Table Fans	SilentPro Pentaflo	62	1350	85	84
6	TPW Table Fans	SDX Black Gold	54	1360	77	84
7	TPW Table Fans	Windmill	54	1360	77	84
8	TPW Pedestal Fans	High Flo Wave Plus	60	1350	85	85
9	TPW Pedestal Fans	High Flo Neo	58	1330	85	86
10	TPW Pedestal Fans	Highspeed Torpedo	125	2100	106	87
11	TPW Pedestal Fans	Whirlwind Gale	120	2100	120	88
12	TPW Pedestal Fans	SilentPro Pentaflo	62	1350	85	89
13	TPW Pedestal Fans	Wind Flo	110	2000	85	90
14	TPW Pedestal Fans	Windmill	54	1360	77	91
15	TPW Pedestal Fans	SDX Black Gold	54	1360	77	92
16	TPW Pedestal Fans	Surebreeze Gladiator	65	1330	90	94
17	TPW Wall Fans	High Flo Wave Plus	60	1350	85	96
18	TPW Wall Fans	High Flo Neo	58	1330	85	96
19	TPW Wall Fans	Highspeed Torpedo	125	2100	105	97
20	TPW Wall Fans	Whirlwind Gale	120	2100	120	97
21	TPW Wall Fans	SilentPro Pentaflo	62	1350	85	98
22	TPW Wall Fans	Wind Flo	110	2000	85	98
23	TPW Wall Fans	SDX Black Gold	54	1360	77	99

Sweep Size - 450 mm

Sr. no	Category	Design Name	Power Inputs (Watts)	Speed (RPM)	Air Delivery (CMM)	Page no.
1	TPW Pedestal Fans	SStorm 2	90	1350	100	93
2	TPW Wall Fans	SStorm 2	90	1350	100	99

Sweep Size - 500 mm

Sr. no	Category	Design Name	Power Inputs (Watts)	Speed (RPM)	Air Delivery (CMM)	Page no.
1	TPW Pedestal Fans	Brizstar Farrata	145	1400	7500	95
2	TPW Pedestal Fans	Windstar Farrata	160	1330	6800	95

Sweep Size - 600 mm

Sr. no	Category	Design Name	Power Inputs (Watts)	Speed (RPM)	Air Delivery (CMM)	Page no.
1	Premion	Aura Prime	65	875	120	46
2	Highspeed	Aura	65	875	120	54
3	Highspeed	Jura	65	875	120	56
4	Highspeed	HS	64	900	120	66
5	Surebreeze	Ariya Briz	64	850	120	71
6	Surebreeze	Cool Breeze	55	860	110	72
7	Surebreeze	Briz Air	62	850	115	73

Sweep Size - 900 mm

Sr. no	Category	Design Name	Power Inputs (Watts)	Speed (RPM)	Air Delivery (CMM)	Page no.
1	Premion	Aura Prime	62	410	155	46
2	Premion	Avancer Prime	56	420	155	48
3	Highspeed	Aura	62	410	155	54
4	Highspeed	Senoprime	60	420	160	54
5	Highspeed	Senorita	60	420	160	55
6	Highspeed	Jura	62	410	155	56
7	Highspeed	HS	60	390	155	66
8	Highspeed	Riviera	60	390	155	67
9	Surebreeze	Super Briz Deco	60	420	140	70
10	Surebreeze	Cool Breeze	65	460	135	72
11	Surebreeze	Briz Air	60	415	145	73

Sweep Size - 1050 mm

Sr. no	Category	Design Name	Power Inputs (Watts)	Speed (RPM)	Air Delivery (CMM)	Page no.
1	Premion	Aura Prime	65	360	190	46
2	Premion	Avancer Prime	68	390	195	48
3	Highspeed	Jura	65	360	190	56
4	Highspeed	HS	66	370	195	66
5	Highspeed	Riviera	66	370	195	67
6	Surebreeze	Cool Breeze	70	420	165	72
7	Surebreeze	Briz Air	68	370	180	73

Sweep Size - 1200 mm

Sr. no	Category	Design Name	Power Inputs (Watts)	Speed (RPM)	Air Delivery (CMM)	Page no.
1	SilentPro	enso	42	315	240	22
2	Energion	Stylus	35	370	220	29
3	Energion	HS	35	370	220	30
4	Energion	Nstar	35	350	220	31
5	Luxian	Uranus	72	320	200	34
6	Luxian	Jupiter	75	300	210	35
7	Luxian	Nebula	72	320	200	36
8	Luxian	Triton Electroplated	70	350	210	37
9	Premion	Aura2 Designer 3D	74	380	230	41
10	Premion	Aura2 Designer 2D	74	380	230	42
11	Premion	Aura2 Designer 2D	74	380	230	43
12	Premion	Aura2 Prime	74	380	230	44
13	Premion	Aura Prime	74	380	230	46
14	Premion	Avancer Prime	77	370	230	48
15	Premion	Dignita	77	370	225	50
16	Premion	Jura Designer	74	380	230	51
17	Highspeed	Aura	74	380	230	54
18	Highspeed	Senoprime	75	370	225	54
19	Highspeed	Senorita	75	370	225	55
20	Highspeed	Jura Prime	74	380	230	55
21	Highspeed	Jura	74	380	230	56
22	Highspeed	Devine	76	370	225	56
23	Highspeed	Diego	72	380	210	57
24	Highspeed	Gianna	75	380	220	58
25	Highspeed	Modern Leaf	72	390	220	59
26	Highspeed	Markle Prime	55	370	225	60
27	Highspeed	Markle Designer	55	370	225	61
28	Highspeed	Bruna	72	380	230	62
29	Highspeed	Rubio	72	380	230	63
30	Highspeed	Splitz	77	370	225	64
31	Highspeed	HS Decora Metallic	70	370	230	64
32	Highspeed	HS Decora	70	370	230	65
33	Highspeed	HS Plus	53	370	218	65

34	Highspeed	HS	70	370	230	66
35	Highspeed	Riviera	72	380	230	67
36	Surebreeze	Super Briz Deco	70	400	210	70
37	Surebreeze	Super Air Deco	70	400	210	70
38	Surebreeze	Ariya Briz Prime	70	370	200	71
39	Surebreeze	Ariya Briz	68	380	210	71
40	Surebreeze	Cool Breeze Deco	75	380	210	72
41	Surebreeze	Cool Breeze	75	380	210	72
42	Surebreeze	Safe Air	75	380	205	73
43	Surebreeze	Briz Air	75	380	205	73
44	Surebreeze	Sea Wind	70	380	200	74
45	Surebreeze	Sea Breeze	70	380	200	74
46	Surebreeze	Alpha Briz	75	380	205	75
47	Surebreeze	Neo Breeze	75	380	205	75
48	Surebreeze	Sea Bliss	65	400	200	76
49	Surebreeze	Star 220	50	360	220	76
50	Surebreeze	Entrust 50	50	370	215	77
51	Surebreeze	Empower 50	50	370	210	77
52	Surebreeze	WWPS	50	310	200	78
53	Surebreeze	WWHE	50	310	200	79

Sweep Size - 1400 mm

Sr. no	Category	Design Name	Power Inputs (Watts)	Speed (RPM)	Air Delivery (CMM)	Page no.
1	Premion	Aura Prime	84	285	270	46
2	Premion	Avancer Prime	84	285	270	48
3	Highspeed	Aura	84	285	270	54
4	Highspeed	Jura	84	285	270	56
5	Highspeed	HS Decora	80	280	270	65
6	Highspeed	HS	80	280	270	66
7	Highspeed	Riviera	85	270	260	67
8	Surebreeze	Super Briz Deco	80	300	245	70
9	Surebreeze	Cool Breeze	82	290	245	72
10	Surebreeze	Briz Air	75	290	245	73
11	Surebreeze	WWHE	60	290	245	79

OUR RANGE OF FANS	100% COPPER WINDING	DOUBLE BALL BEARING	ANTI RUST	ANTI DUST	5 YEAR WARRANTY	50% ENERGY SAVINGS	2X SILENT	UNDERLIGHT
SUREBREEZE	✓	✓	✓*					
HIGHSPEED	✓	✓	✓	✓*				
PREMION	✓	✓	✓	✓	✓*			
ENERGION	✓	✓	✓	✓*	✓	✓		✓*
SILENTPRO	✓	✓	✓	✓*	✓	✓	✓	✓*
LUXIAN	✓	✓	✓					✓*

*In select models only.

Crompton

CROMPTON GREAVES CONSUMER ELECTRICALS LIMITED

Registered Office:

Equinox Business Park, 1st Floor, Tower 3, LBS Marg, Kurla (W), Mumbai - 400 070, India.

Customer Service:

Toll free number: **1800 419 0505** (Mon to Sat: 9am - 7pm)

Web registration on www.crompton.co.in

Disclaimer - While every effort has been taken to ensure that all specifications and description are correct, this brochure should not be regarded as an infallible guide and not as an offer of sales for a particular product. Due to variables in production process, colours of actual products may vary slightly from those depicted. Model numbers and specifications are for reference only.
May subject to change without prior notice.