

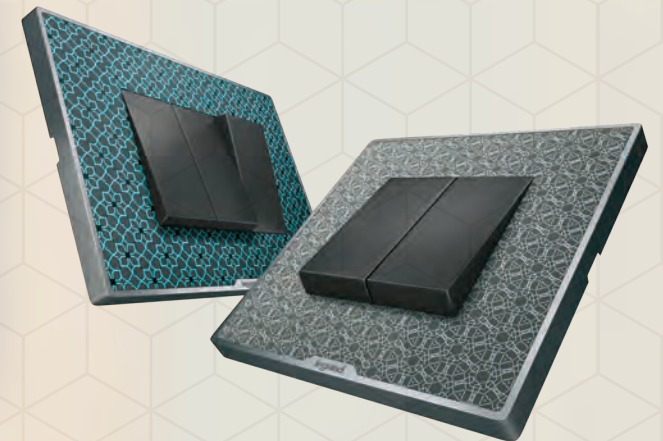

MYRIUS[®]
NEXTGEN

INSPIRED
BY YOU
CRAFTED
BY US



 **legrand[®]**

LIVE THE ADVANTAGE





with you at
THE HEART

At Legrand when we dream up something new, guess who drives us to dream bigger? When our engineers do umpteen extra-trials, wonder who do they do it for? When our craftsmen happily work overtime, who secretly motivates them?

Every piece of technology, every byte of data and every stroke of design is created by us, with you at the heart.

The state-of-the-art Myrius NextGen range has been inspired by the lives you lead. Inspired by what the little ones love most or what grandpas and grannies adore. Inspired by what husbands and wives love or sometimes even fight over.

When such inspirations meet Legrand's famed 'Designing' philosophy, what you get is the stunning Myrius NextGen range.

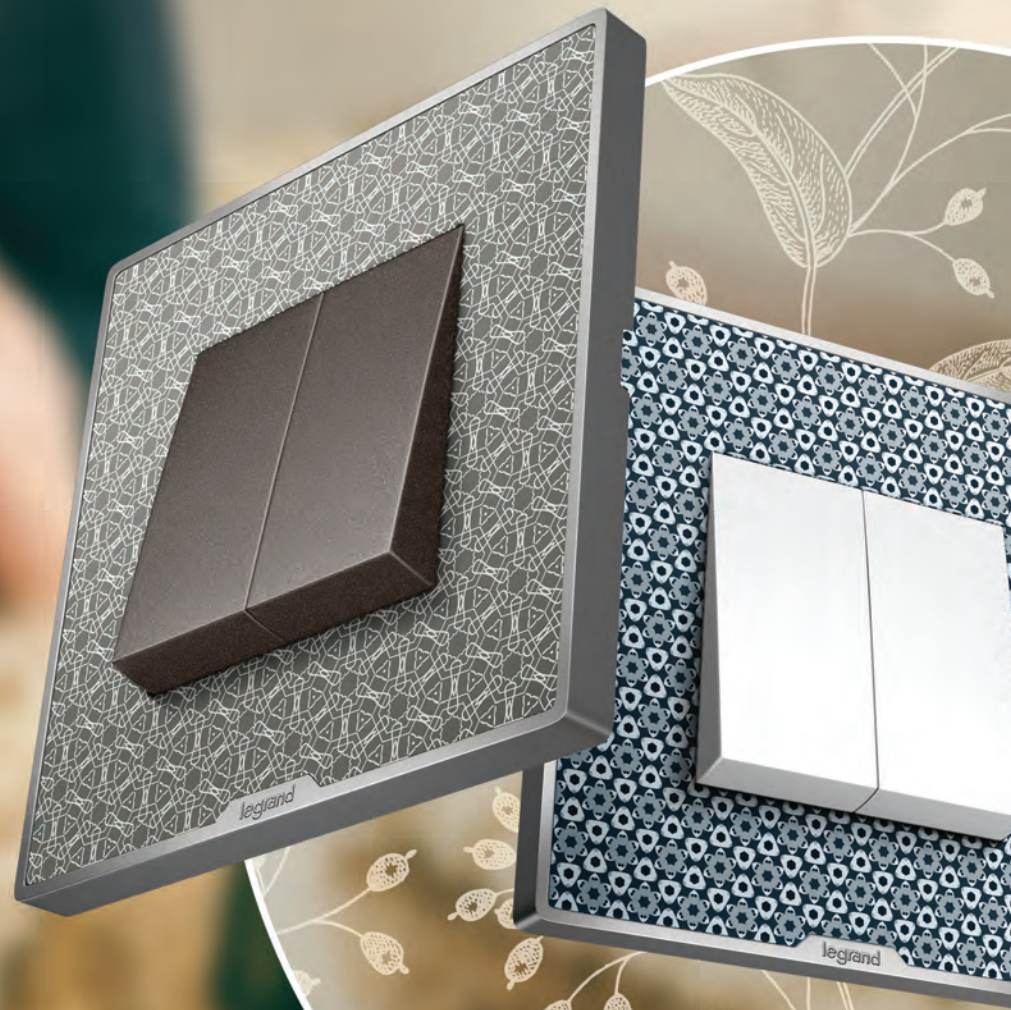
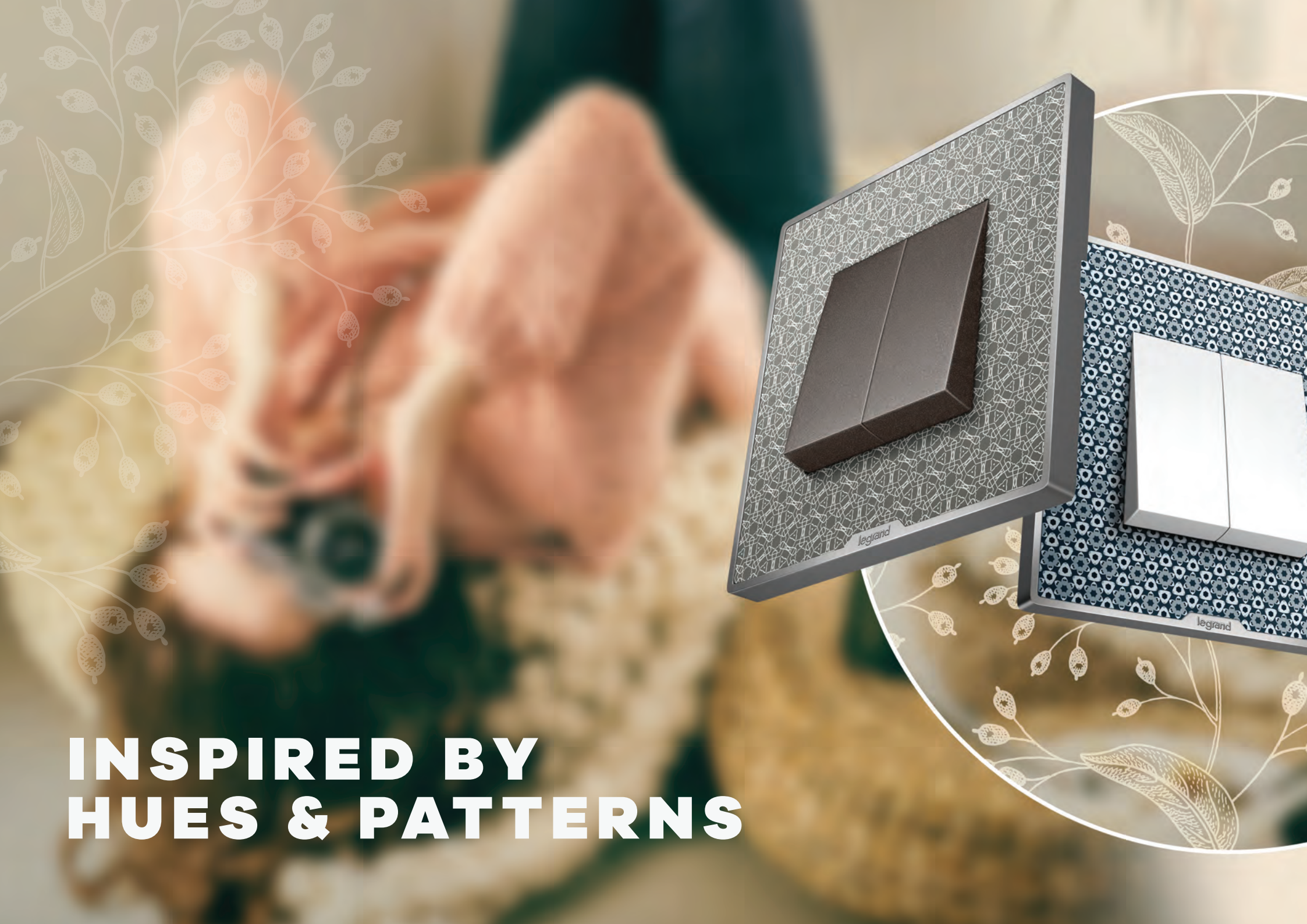

**INSPIRED BY
HUES & PATTERNS**



We know just how much India loves its colours and motifs. Crafted by the latest In Mold Decoration (IMD) technology, our CE Certified plates come in myriad colours and unique patterned finishes. With unmatched consistency in quality and the finish of patterns, these modern, sleek and flat designs will add a touch of designer class to any room. So, be it an understated pattern or a bold, colourful look that becomes a showstopper - take your pick from 10 different finishes and live the advantage.







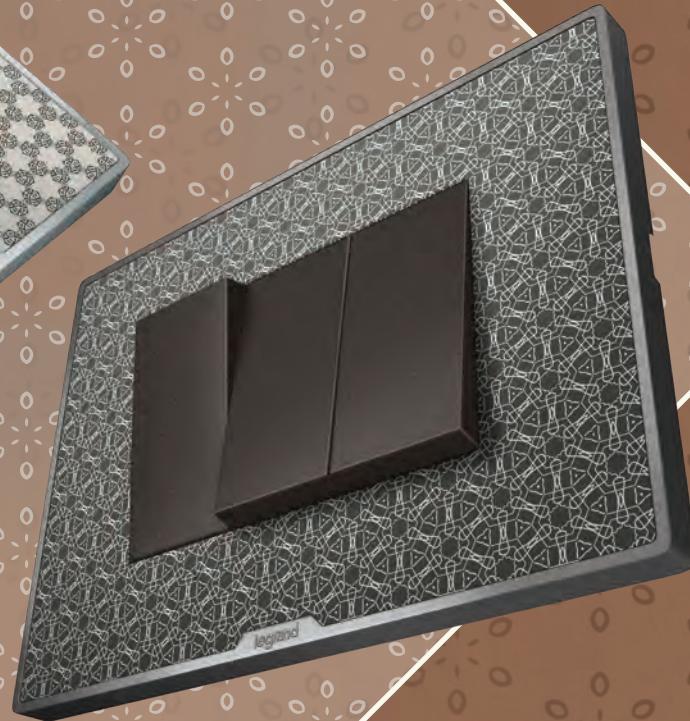
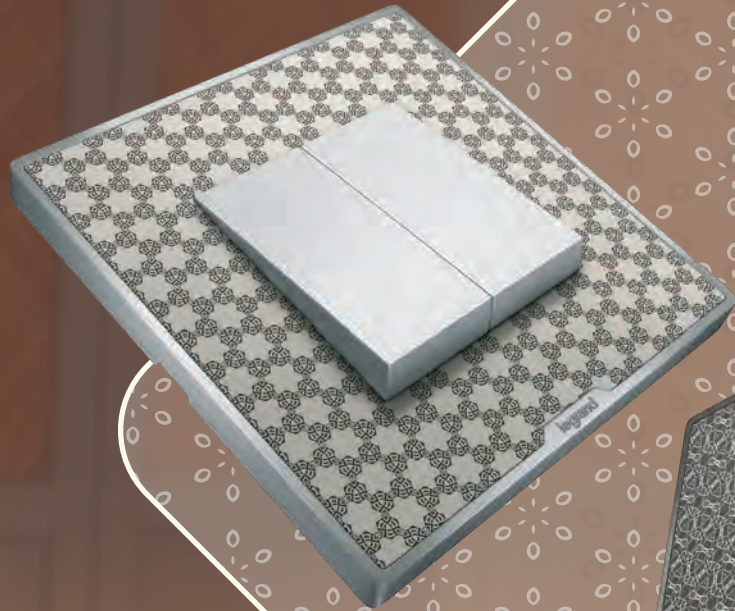



Anti-bacterial
Switch

INSPIRED BY YOUR HEALTH-FIRST MANTRA

You prioritize your family's health, hygiene and wellness more than anything else. Inspired, we've created anti-bacterial plates infused with silver ions, which do not let bacteria grow on the surface of switches and plates and accessories throughout its lifespan. One less reason to worry about germs being passed on at home. Live the advantage of a healthy home.





CHARGING SOLUTIONS







Twin USB
Type A+C

Combi USB Type C+C and
multi-standard Socket

INSPIRED BY YOUR ALWAYS-ON LIFESTYLE

Different users have different requirements. Thankfully our range of Type A and Type C charging solutions ensures that whatever be your type, you'll never run out of charge! And we've been the first to introduce and follow IS standard and the mandatory CRS declaration as per BIS norms. So, live the advantage of so many options





**INSPIRED BY YOUR
CLUTTER-FREE LIFE**



Induction charger*

We all love a life devoid of clutter. A minimal, yet beautiful existence. Just like our induction charger. Forget using messy charging wires for your phone. Simply place it in the induction charger's slot or plug in with USB Port and voila – in no time at all, you have a fully charged phone, without the mess of untangling wires! Live the advantage of a tangle-free life.

*Only charges compatible phones with induction receiver technology



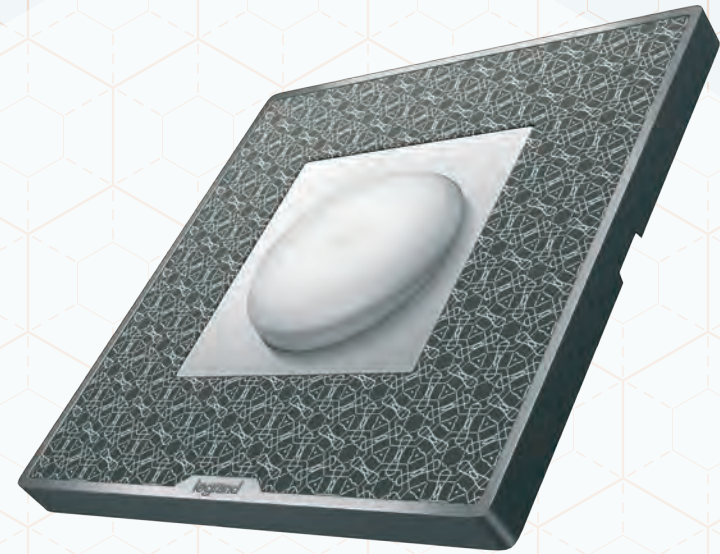

**SMART
CONVENIENCE**





Bluetooth Sound receiver
and Ceiling Speaker

INSPIRED BY THE SECRET PERFORMER IN YOU

Be it crooning alongside your favourite numbers or just jumping up on the bed and dancing to it like no one's watching – we know everyone secretly wants to do these. Our Bluetooth sound receiver and ceiling speaker helps you unlock the performer in you. Thanks to crystal clear audio that turns any room into a concert venue. Live the advantage of enjoying your musical side.





INSPIRED BY YOUR LOVE FOR A GREAT STORY

We know how much you love your page-turners and even a quiet nap in between chapters. Which is why our Modular, Flexible and Dimmable Reading lamp is just perfect. Bright when you are lost in the story and easily dimmed when you want a bit of shuteye. Live the advantage of convenience with an ultra-modern design.



INSPIRED BY YOUR ALWAYS-READY MANTRA OF LIVING

Be prepared – it's one of your favourite philosophies in life, isn't it? We anticipated it. Just as we anticipate any sudden emergency, power cuts or an impromptu adventure into the dark outdoors. Our removable emergency LED lamp is just the right thing you need to show you the way, when all other light fails. Live the advantage of ease.





INSPIRED BY A TOUCH OF YOU

Touch switches in a unique Titane finish. Tested individually for several thousand operations. The promise of long life and low power consumption. High gloss finishing that facilitates easy cleaning. And in-built memory feature for electronic touch switches. When it comes to our touch switches we've kept in mind your needs and touched upon all of them! So, go ahead and live the advantage.



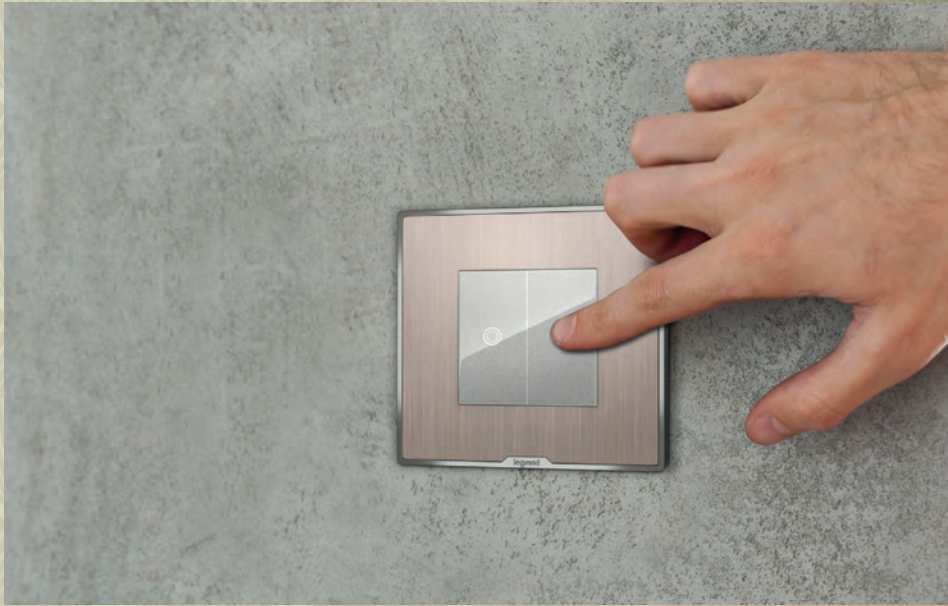

INSPIRED BY YOUR NEED TO STANDOUT

Our Touch Switches bring the ease of convenience and the looks of outstanding design. Modern, sleek, minimal, we are inspired by your global tastes, to make your home as aesthetic as it gets.



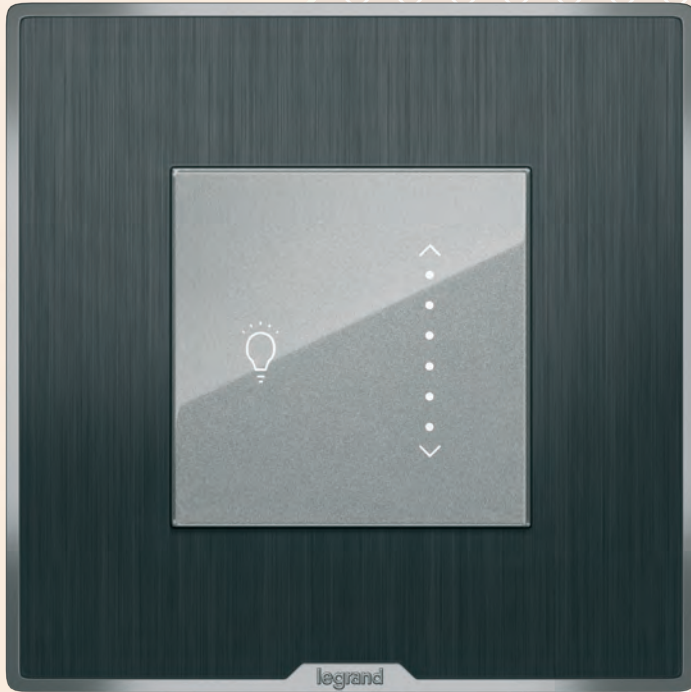

Touch Universal LED dimmer



INSPIRED BY YOUR BRIGHT LIFESTYLE

Our Touch Universal Dimmer for all types of dimmable loads, including LED, lets you decide whether you want a dimly lit ambience or a bright as day look





Touch Curtain
Control Switch

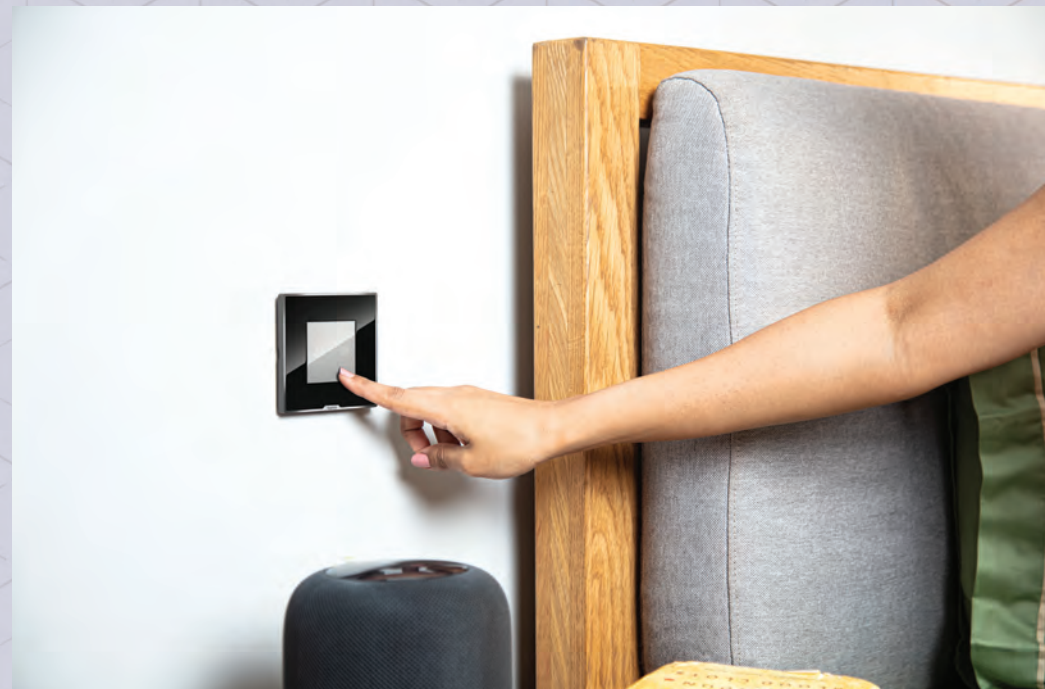

INSPIRED BY YOUR MOMENTS BY THE WINDOW

There are moments that you love to draw the curtains apart, sit by the window and look outside as the world passes by. Yet, there are days when you want to shut out the world outside. Our touch curtain control switches are there for you, either way. Live the advantage of privacy or let the world enter through your windows.



COMMERCIAL/HOSPITALITY SOLUTIONS



INSPIRED BY YOUR PRESENCE AND YOUR ABSENCE!

Be it a hotel lobby, corridor or a verandah in your home – wouldn't it be nice if the lights knew that you are on your way and turn themselves on, according to your presence? We thought you might like it. Our engineers therefore have designed the Infrared Sensor Switch which senses your presence or absence and accordingly switches on or off the lights. Saves power and the trouble too! Live the advantage of smartness.









Preterminated
HDMI socket

INSPIRED BY YOUR NEED FOR TECHNOLOGY

Plug in any of your favourite devices that run on HDMI, using our preterminated HDMI Socket. The ease of installation of this socket, means everyone can easily live the advantage of entertainment, technology and convenience.

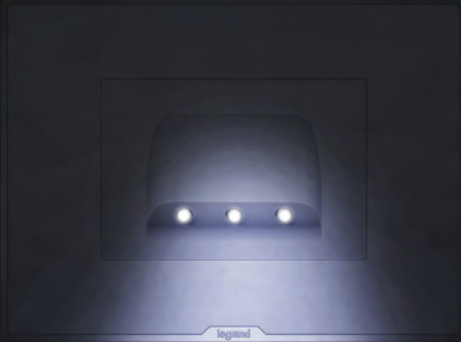



INSPIRED BY YOUR LOVE FOR LATE NIGHTS

Be it a cosy room in a resort or a long corridor in a swanky hotel, we know the need for the softest yet warmest guiding lights that show the way, even in the dark. Hence, we've come up with a Skirting Light that is just perfect in terms of illumination, while not disturbing everyone around. Live the advantage of lights in the dark.





**THE WONDER OF
IOT IN HOMES**





INSPIRED BY YOUR INTELLIGENCE THAT LIGHTS UP ROOMS

When you walk into rooms, they say you light it up with your conversations. Taking our cue and using the intelligence of IoT technology we've created central control of switches, shutters and socket, individual and group based. Live the advantage of smart technology.



Curtain/Roller Blind Wireless Switch

INSPIRED BY THE SUN PLAYING HIDE AND SEEK WITH YOU

We know sometimes you prefer the sunrays bathing you and sometimes you want to shut them out. Our IoT Enabled Curtain/ Roller Blind Wireless Switch will do the job. Live the advantage of smart comforts.





Gateway



Home/Away Wireless
Master Switch

INSPIRED BY YOUR JET-SETTING LIFE

Today you are home and tomorrow you are travelling – a holiday or perhaps a work-trip. We know such jetsetters need some intelligent help at home. Our IoT enabled Home/Away Wireless Master Switch lets you switch on or off multiple things like all lights, all shutters or all sockets by just pressing one switch at home or by tapping the app on your phone, even when you are not home! Live the advantage of technology that keeps up with you.







Wake Up/Sleep Wireless Scenario Switch

INSPIRED BY YOUR GOOD NIGHT'S SLEEP

You value the quality of your sleep. And we value the experience that starts before you drift off and the one that awaits when you wake up. Our IoT Enabled Wake up/Sleep wireless scenario switch lets you manage, control and set these scenarios. An intelligent treatment awaits every time you want to sleep or wake up. Live the advantage, every waking hour or even in your dreams!

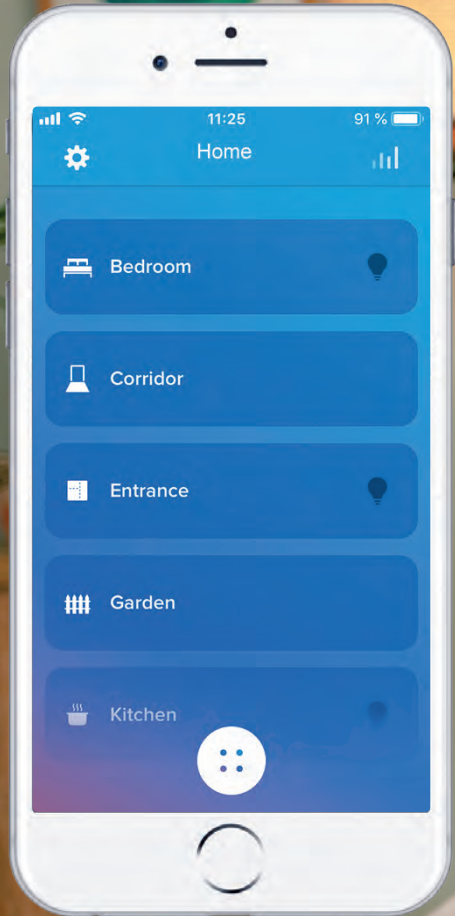

Wireless Switch

INSPIRED BY TOUCH, SWIPE AND YOUR VOICE.

Be it controlling operations of lights or curtains remotely or controlling power outlets or viewing energy consumption details – we've got your back in multiple ways that you love. Control functions via voice commands used in combination with multiple ways. You can still use it in the traditional way via switches on wall. Also even by simply swiping on the Home+Control Smartphone app by Legrand.

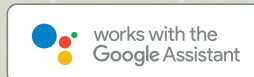
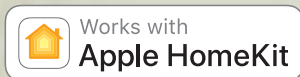

iPhone, iPod and iPad are registered trademarks of Apple Inc, registered in the US other Countries. HomeKit is a trademark of Apple Inc. App Store is a service mark of Apple Inc., Google, Android, Google Play, and the Google Play logo are trademarks of Google LLC. Amazon, Alexa and all related logos are trademarks of Amazon, Inc. or its affiliates.



INSPIRED BY YOUR LOVE FOR THE HIGHEST STANDARDS

When it comes to certifications, we've left no stone unturned. The best of national and international compliances and certifications have been met in our several products. Legrand is proud to be a part of the prestigious PEP Ecopassport* program, making sustainability quotient top notch. After all we must keep up with your high standards, right? Live the advantage of the very best standards.





INSPIRED
BY YOU
CRAFTED
BY US

Switches - Classic White



Switches are ISI marked as per the latest IS 3854:1997
First time in India- Unique Indicator design

Pack	Cat.Nos	Switches 6A 230V AC	No. of modules
20/200	6 792 00	6A Switch 1 way 1M White	1
20/200	6 792 01	6A Switch 2 way 1M White	1
20/200	6 792 02	6A Switch 1 way 1M with indicator White	1
20/200	6 792 03	6A Switch 1 way 1M Light marking White	1
20/200	6 792 04	6A Switch 1 way 1M with Fan marking White	1
Switches 10A 230V AC			
10/100	6 792 05	10A Switch 1 way 2M White	2
10/100	6 792 06	10A Switch 2 way 2M White	2
10/100	6 792 07	10A Intermediate Switch 2M White	2
10/100	6 792 08	10A Switch 1 way 2M with Indicator White	2
Switches 16A 230V AC			
20/200	6 792 09	16A Switch 1 way 1M White	1
20/200	6 792 10	16A Switch 2 way 1M White	1
20/200	6 792 11	16A Switch 1 way 1M with Indicator White	1

Pack	Cat.Nos	Switches 20A 230V AC	No. of Modules
20/200	6 792 12	20A Switch 1 way 1M White	1
10/100	6 792 13	20A DP Switch 1 way 2M White	2
10/100	6 792 14	20A DP Switch 1 way 2M with Indicator White	2
10/100	6 792 15	20A Switch 2 way 2M White	2
Switches 25A 230V AC			
20/200	6 792 16	25A SP 1 way with Indicator 1M White	1
Switches 32A 230V AC			
10/100	6 792 17	32A DP Switch 2M with Indicator White	2

Push Buttons



Pack	Cat.Nos	Push Button 6A 230V AC
20/200	6 792 18	6A Push Button SP 1M White
20/200	6 792 19	6A Push Button SP 1 way 1M with Indicator White
20/200	6 792 20	6A Bell Push 1 way 1M White
20/200	6 792 21	6A Bell Push 1 way 1M with Indicator White
10/100	6 792 22	6A Bell Push 1 way 2M White
10/100	6 792 23	6A Bell Push 1 way 2M with Indicator White

Pack	Cat.Nos	Accessories for switches
5/50	6 792 24	Lamp for Switches 230 V AC

No. of Modules
1
1
1
1
2
2
-

Sockets

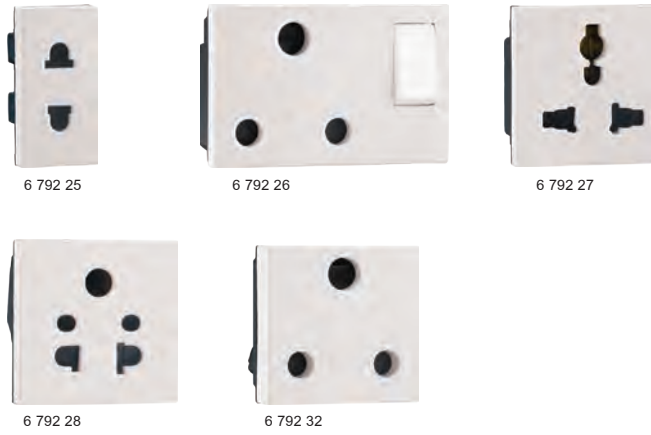

Pack	Cat.Nos	Sockets 240V AC	No. of Modules
Conforming to IS 1293 : 2019 Shuttered for Child Safety Shutter opens only with phase and neutral insertion simultaneously.			
20/200	6 792 25	6/16A 2 Pin Euro-US Socket 1 Module	1
5/50	6 792 26	16 A 3 Pin Switched Socket 3M	3
10/100	6 792 27	Multistandard Socket, 2/3 Pin - 6/10/13A 250V AC 2 Pin - 15A for 127V, 2 Module	2
20/200	6 792 28	6A 5 Pin Universal Socket 2M White	2
5/50	6 792 29	6/16A Socket 3M White	3
10/100	6 792 30	6/16A Socket 2M White	2
10/100	6 792 32	25A Socket 2M White	2

Dimmers, Fan Regulators, Emergency Light, Skirting Light and Indicators



Bell Call Indicator, Buzzer, Infrared Sensors and Remote unit



Pack	Cat.Nos	Dimmers and Fan regulators	No. of modules
		Fan regulators with ISI mark Fan regulators with ease of speed selection Fan regulator models available to suite all Ceiling Fans High capacity sturdy design Light Dimmers	
5/50	6 792 36	Rotary Dimmer 400W 1M White	1
10/100	6 792 37	Rotary Light Dimmer 500W 2M White	2
5/50	6 792 39	Fan Regulator 100W 1M White	1
10/100	6 792 40	Fan Regulator 100W 360 Degree 2M White	2
10/100	6 792 41	Fan Regulator 120W 360 Degree 2M White	2
1/10/100	6 792 42	Fan Regulator 70W 2M White	2
		Emergency Light	
		Unique portable torch design with battery backup White Light for better visibility	
1/10/100	6 792 43	Removable LED lamp 2M White	2
		Skirting Light	
		Skirting Light with warm White LED 3M White	
5/25	6 792 48	Skirting Light with warm White LED 3M White	3
		Indicator	
1/10/100	6 792 87	Indicator unit 1M with transparent LED with colored labels White	1

Pack	Cat.Nos	Bell Call Indicator	No. of Modules
20/200	6 792 49	Bell Call Indicator 1M White	1
		Buzzer	
20/200	6 792 50	Buzzer 230V 1M White	1
		Infrared sensors	
		High sensitive design with sensitivity and time adjustment Suitable for all type of loads	
1/50	6 792 51	Infrared sensor Switch 400W 2M White	2
		Remote unit	
		Sleek, high quality, modular 4 switch remote unit Suitable for all type of loads	
1/5/20	6 792 52	Remote control unit for Light and fan 4M White	4
1/5/30	6 793 03	Remote control hand unit	-

Hospitality function



Pack	Cat.Nos	Hotel Keycard Switch
1/10	6 792 53	16 A Key card switch Suitable for all type of loads Isolated contacts for switch function
10/100	6 792 55	16A Hotel Key FOB Switch 2M White Credit card size Key FOB
10/100	6 792 56	DND & CMR Indicator 1M + 1M Bell Push White
10/100	6 792 57	DND & CMR (inside) White
1/16	6 792 58	Shaver Socket 110/230V AC Monoblock with plate Ease for voltage selection
1/5/20	6 792 59	Shaver Socket 110/230V AC Monoblock with plate White 4M

No. of Modules

- 2
- 2
- 2
- 2
- 2
- 4

Sockets and Connectors



Pack	Cat.Nos	T.V Sockets	No. of Modules
20/200	6 792 60	T.V co-axial Socket White	1
20/200	6 792 62	RJ11 Telephone White	1
20/200	6 792 63	Double RJ11 Telephone White	1
20/200	6 792 64	RJ 45 UTP CAT 5 tooless with shutter 1M White	1
20/200	6 792 65	RJ 45 UTP CAT 6 tooless with shutter 1M White	1
10/100	6 792 66	RJ 45 UTP CAT 6 tooless with shutter 2M White	2
1/10	6 792 67	Preterminated AV connector 1M White	1

Audio-Video Connectors

Used to transmit high-definition digital/analog audio/video streams between a source (Blu-ray player, computer) and a compatible receiver (TV, LCD video projector...)



Pack	Cat.Nos	Audio-Video Connectors
1/10	6 792 68	Preterminated projector connector 1M White
1/10	6 792 69	Preterminated HDMI Socket 1M White
Sound (Volume Controller)		
1/10/100	6 792 70	Volume Controller 2M
Protectors and Accessories		
1/10/100	6 792 71	16A Motor starter 2M White
1/10/100	6 792 72	25A Motor starter 2M White
USB chargers (IS13252 (Part 1) / IEC 60950-1)		
Complete family of USB chargers available First time in India - USB C type Charger for fast charging with mandatory CRS marking		
1/5/50	6 792 88	USB charger 1500 mA 1M type A White
1/10/100	6 792 89	USB charger 3000 mA 2M type A & C White
1/5/50	6 792 90	USB charger 1500 mA 1M type C White

No. of Modules
1
1
2
2
2
1
2
1



Pack	Cat.Nos	Combi (Socket+USB)	
Combi USB tested for optimum operation with high output efficiency			
1/5/50	6 792 92	Combi twin USB 3100 mA Multistandard Socket type A	3
1/5/50	6 792 93	Combi twin USB 3100 mA Multistandard Socket type A & type C	3
1/5/50	6 792 94	Combi twin USB 3100 mA Multistandard Socket type C	3
Wireless Charger			
Efficient charging tested as per international standard Modular installation Mobile holder present Available USB for wire charging			
1/4	6 792 95	Induction charger 1A wireless 2.4A USB + dock 2M SUP with mech White 1A charger and one 2.4A USB port to power second device *** charging only with wireless compatible phone having Induction receiver technology.	2
Loud Speakers			
1/6	6 792 98	Compact 6W RMS easy hooking intallation 86db (1W/1M) Sensitivity Ideal for living room, kitchen, Bedroom, offices, canteen Ceiling Loudspeaker 8 Ohms 100mm White	-

Electronic function (contd.)



Pack	Cat.Nos	Sound Diffusion	
1/10/100	6 792 99	<p>Bluetooth Technology. Voice messages for easy understanding Compact 2M design with all control functions Inbuilt amplifier, 1.5W X2 with 8 Ohms speaker Ideal for living room, kitchen, Bedroom, offices, canteen Greater than 8 m range</p> <p> Bluetooth sound diffusion 2M</p>	2
1/10/120	6 793 04	<p>Rotary Dimmer Universal</p> <p>First time in India-High quality universal dimmer for all type of Light loads including LED loads Comes in 1 Module</p> <p> Rotary LED Light dimmer 1M - 50W White</p>	1
1/50	6 793 08	<p>Touch Switches</p> <p>Range of touch switches Tested for > 40000 switching operations at full load Capacitive touch activation with big touch area for ON THE GO switching</p> <p> Touch Switch 2M 1 way 2 Switch 1000W</p>	2
1/50	6 793 09	<p> Touch Switch 2M 1 way 1440W</p>	2
1/50	6 793 10	<p> Touch Switch 2M 2 way 1000W</p>	2
1/50	6 793 13	<p> Touch Switch 2M 1 way 3000W</p>	2
1/50	6 793 06	<p> Touch Switch Bell Push 2M 1440W</p>	2

Pack	Cat.Nos	Touch Regulator, Curtain & Dimmer	No. of Modules
1/50	6 793 07	<p>5 step touch Fan regulator Universal scroll type Light dimmer for all type of loads</p> <p> Touch Switch - curtain controller 2M</p>	2
1/50	6 793 05	<p> Touch Fan Regulator 2M 100W</p>	2
1/50	6 793 15	<p> 300W universal LED touch scroll Dimmer 2M</p>	2
1/10	6 793 16	<p>Reading Light</p> <p>Modular & Flexible handy Light with brightness adjustment Ideal for bedside or table wall installation Warm White light for comfortable reading</p> <p> Reading Light LED 2M White</p>	2
20/200	6 792 75	<p> Cable outlet 8mm 1M White</p>	1
40/400	6 792 76	<p> Blanking plate 1M White</p>	1
10/100	6 792 77	<p> Blanking plate 2M White</p>	2

Switches - Charcoal grey



Switches are ISI marked as per the latest IS 3854:1997
First time in India - Unique Indicator design

Pack	Cat.Nos	Switches 6A 230V AC
20/200	6 794 00	6A Switch 1 way 1M Charcoal Grey
20/200	6 794 01	6A Switch 2 way 1M Charcoal Grey
20/200	6 794 02	6A Switch 1 way 1M with Indicator Charcoal Grey
20/200	6 794 03	6A Switch 1 way 1M with Light marking Charcoal Grey
20/200	6 794 04	6A Switch 1 way 1M with Fan marking Charcoal Grey

Pack	Cat.Nos	Switches 10 A 230 V AC
10/100	6 794 05	10A Switch 1 way 2M Charcoal Grey
10/100	6 794 06	10A Switch 2 way 2M Charcoal Grey
10/100	6 794 07	10A intermediate Switch 2M Charcoal Grey
10/100	6 794 08	10A Switch 1 way 2M with Indicator Charcoal Grey

Pack	Cat.Nos	Switches 16A 230V AC
20/200	6 794 09	16A Switch 1 way 1M Charcoal Grey
20/200	6 794 10	16A Switch 2 way 1M Charcoal Grey
20/200	6 794 11	16A Switch 1 way 1M with Indicator Charcoal Grey

No. of Modules

1
1
1
1
1
1
2
2
2
2
1
1
1

Pack	Cat.Nos	Switches 20A 230V AC
20/200	6 794 12	20A Switch 1 way 1M Charcoal Grey
10/100	6 794 13	20A DP Switch 1 way 2M Charcoal Grey
10/100	6 794 14	20A DP Switch 1 way 2M with Indicator Charcoal Grey
10/100	6 794 15	20A Switch 2 way 2M Charcoal Grey

Pack	Cat.Nos	Switches 25A 230V AC
20/200	6 794 16	25A SP 1 way with Indicator Charcoal Grey 1M

Pack	Cat.Nos	Switches 32A 230V AC
10/100	6 794 17	32A DP Switch 2M with Indicator Charcoal Grey

No. of Modules

1
2
2
2
1
2

Push buttons



Pack	Cat.Nos	Push Button 6A 230V AC
20/200	6 794 18	6A Push Button SP 1 way 1M Charcoal Grey
20/200	6 794 19	6A Push Button 1 way 1M Indicator Charcoal Grey
20/200	6 794 20	6A Bell Push 1 way 1M Charcoal Grey
20/200	6 794 21	6A Bell Push 1 way 1M with Indicator Charcoal Grey
10/100	6 794 22	6A Bell Push 1 way 2M Charcoal Grey
10/100	6 794 23	6A Bell Push 1 way 2M with Indicator Charcoal Grey

No. of Modules
1
1
1
1
2
2

Sockets

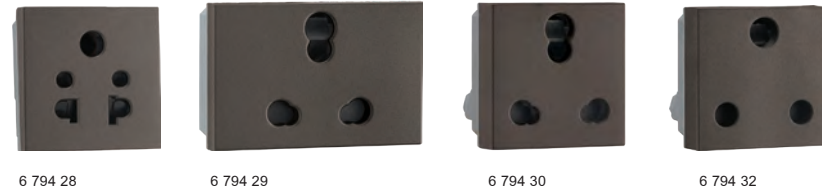

Pack	Cat.Nos	Sockets 240V AC	No. of Modules
		Conforming to IS 1293 : 2019 Shuttered for Child Safety Shutter opens only with phase and neutral insertion simultaneously	
20/200	6 794 24	6/16 A 2 pin Euro US Socket 1M Charcoal Grey	1
5/50	6 794 26	16 A 3 pin Switched Socket 3M Charcoal Grey	3
10/100	6 794 25	Multistandard Socket, 2/3 Pin - 6/10/13A 250V AC 2 Pin -15A for 127V, 2 Module Charcoal Grey	2
20/200	6 794 28	6A 5 Pin Universal Socket 2M Charcoal Grey	2
5/50	6 794 29	6/16A Socket 3M Charcoal Grey	3
10/100	6 794 30	6/16A Socket 2M Charcoal Grey	2
10/100	6 794 32	25 A Socket 2M Charcoal Grey	2

Fan regulator and dimmer



6 794 36 6 794 37 6 794 39

Pack	Cat.Nos	Dimmers and Fan Regulators	
		Fan regulators with ISI mark Fan regulators with ease of speed selection Fan regulator models available to suite almost all Ceiling Fans High capacity sturdy design Light dimmers	
5/50	6 794 36		Rotary Dimmer 400W 1M Charcoal Grey
10/100	6 794 37		Rotary Light Dimmer 500W 2M Charcoal Grey
5/50	6 794 39		Fan Regulator 100W 1M Charcoal Grey
10/100	6 794 40		Fan Regulator 100W 360 Degree 2M Charcoal Grey
10/100	6 794 41		Fan Regulator 120W 360 Degree 2M Charcoal Grey
1/10/100	6 794 42		Fan Regulator 70W 2M Charcoal Grey
		Skirting Light	
5/25	6 794 48		Skirting Light with Warm White LED 3M Charcoal Grey

No. of Modules

1
2
1
2
2
2

Skirting light, bell call indicators, buzzer, remote unit



6 794 49 6 794 50 6 794 52 6 793 03

Pack	Cat.Nos	Bell Call Indicator		No. of Modules
20/200	6 794 49		Bell Call indicator Charcoal Grey 1M	1
		Buzzer		
20/200	6 794 50		Buzzer 230V 1M Charcoal Grey	1
		Remote Unit		
		Sleek, high quality, modular 4 switch Remote unit suitable for all type of loads		
1/5/20	6 794 52		Remote control unit for Light and Fan 4M Charcoal Grey	4
1/5/30	6 793 03		Remote control hand unit	-

Hospitality functions



Pack	Cat.Nos	Hospitality Function	No. of Modules
1/10	6 794 53	Hotel Keycard Switch 16A Key card switch Suitable for all type of loads Isolated contacts for Switch function	2
10/100	6 792 55	16A Hotel Key FOB SW Charcoal Grey Credit card size Key FOB	-
10/100	6 794 54	Hotel "DND and MMR" functions DND & CMR Indicator 1M + 1M Bell Push Charcoal Grey	2
10/100	6 794 55	DND & CMR (inside) Charcoal Grey	2
1/16	6 794 58	Shaver Socket 120/240V AC Monoblock with plate 2M Charcoal Grey	2
1/5/20	6 794 59	Shaver Socket 120/230V AC Monoblock with plate 4M Charcoal Grey	4

Sockets and connectors



Pack	Cat.Nos	TV Sockets	No. of Modules
20/200	6 794 60	T.V co-axial Socket Charcoal Grey	1
20/200	6 794 62	Data & Voice RJ11 Telephone Charcoal Grey	1
20/200	6 794 63	Double RJ11 Telephone Charcoal Grey	1
20/200	6 794 64	RJ 45 UTP CAT 5 tooless with shutter 1M Charcoal Grey	1
20/200	6 794 65	RJ 45 UTP CAT 6 tooless with shutter 1M Charcoal Grey	1
10/100	6 794 66	RJ 45 UTP CAT 6 tooless with shutter 2M Charcoal Grey	2
1/10	6 794 67	Audio Video sockets Used to transmit high-definition digital/analog Audio/Video streams between a source (Blu-ray player, computer) and a compatible receiver (T.V, LCD video projector...) Preterminated AV connector 1M Charcoal Grey	1
1/10	6 794 68	Preterminated HDMI Socket 1M Charcoal Grey	1
1/10	6 794 69	Preterminated projector connector 1M Charcoal Grey	1
1/10/100	6 794 70	Sound (Volume Controller) Volume Controller 2M Charcoal Grey	2

Electronic function



Pack	Cat.Nos	Motor Starter	No. of Modules
1/10/100	6 794 71	16A Motor Starter 2M Charcoal Grey	2
1/10/100	6 794 72	25A Motor Starter 2M Charcoal Grey	2
USB Chargers (IS13252 (Part 1) / IEC 60950-1)			
Complete family of USB chargers available First time in India - USB C type Charger for fast charging with mandatory CRS marking			
1/5/100	6 794 88	USB charger 1500 mA 1M type A Charcoal Grey	1
1/10/100	6 794 89	USB charger 3000 mA 2M type A & C Charcoal Grey	2
1/5/100	6 794 90	USB charger 1500 mA 1M type C Charcoal Grey	1
Combi (Socket+USB)			
Combi USB tested for optimum operation with high output efficiency			
1/5/50	6 794 92	Combi twin USB 3100 mA multistandard Socket type A Charcoal Grey	3
1/5/50	6 794 93	Combi twin USB 3100 mA multistandard Socket type A & type C Charcoal Grey	3
1/5/50	6 794 94	Combi twin USB 3100 mA multistandard Socket type C Charcoal Grey	3

Pack	Cat.Nos	Sound Diffusion	No. of Modules
Bluetooth Technology. Voice messages for easy understanding Compact 2M design with all control functions Inbuilt amplifier, 1.5W X2 with 8 Ohms speaker Ideal for living room, kitchen, Bedroom, offices, canteen Greater than 8m range			
1/10/100	6 794 97	Bluetooth sound diffusion 2M Charcoal Grey	2
Rotary Dimmer Universal			
First time in India-High quality universal dimmer for all type of light loads including LED loads Comes in 1 module			
1/10/120	6 794 98	Rotary LED Light Dimmer 50W 1M Charcoal Grey	1
Accessories			
20/200	6 794 75	Cable outlet 8mm 1M Charcoal Grey	1
40/400	6 794 76	Blanking plate 1M Charcoal Grey	1

Switches - Classic white (Antibacterial Range)

Switches are ISI marked as per the latest IS 3854:1997
 First time in India- Unique Signature design.
 With Anti-Bacterial properties

Pack	Cat.Nos	Switches 6A 230V AC	No. of Modules
20/200	6 793 20	6A SW 1 way 1M White Anti-Bacterial	1
20/200	6 793 21	6A SW 2 way 1M White Anti-Bacterial	1
20/200	6 793 24	6A Bell Push 1M White Anti-Bacterial	1
Switches 16A 230V AC			
20/200	6 793 22	16A SW 1 way 1M White Anti-Bacterial	1
20/200	6 793 23	16A SW 2 way 1M White Anti-Bacterial	1
Sockets 240V AC			
Conforming to IS 1293 : 2019 Shuttered for Child Safety Shutter opens only with phase and neutral insertion simultaneously.			
10/100	6 793 26	Multistandard Socket, 2/3 Pin - 6/10/13A 250V AC 2 Pin -15A for 127V, 2M	2
20/200	6 793 27	6A 5 Pin Universal Socket 2M	2
10/100	6 793 28	6/16A Socket 2M	2
5/50	6 793 29	6/16A Socket 3M	3

Pack	Cat.Nos	Fan Regulators	No. of Modules
Fan Regulators with ISI mark Fan Regulators with ease of speed selection Fan Regulator models available to suite almost all Ceiling Fans			
10/100	6 793 25	Fan Regulator 120W 360 Degree 2M	2
TV sockets			
20/200	6 793 30	TV. Socket 1M Anti-Bacterial	1
Data & Voice			
20/200	6 793 31	RJ 11 Telephone Socket 1M Anti-Bacterial	1
20/200	6 793 32	RJ 45 CAT 6 UTP Anti-Bacterial 1M	1
Accessories			
40/400	6 793 33	Blanking plate 1M White Anti-Bacterial	1

Plates with frame



6 795 02 6 795 04



6 795 22 6 795 23



6 795 06 6 795 08



6 795 24 6 795 28

Pack	Cat.Nos	Plate Frame White	No. of Modules	Dimension (mm)
20/200	6 795 01	Plate+frame 1M White	1	86 x 86
20/200	6 795 02	Plate+frame 2M White	2	86 x 86
10/100	6 795 03	Plate+frame 3M White	3	86 x 121
10/100	6 795 04	Plate+frame 4M White	4	86 x 146
5/50	6 795 06	Plate+frame 6M White	6	86 x 224
5/50	6 795 08	Plate+frame 8M White	8	86 x 245
5/25	6 795 09	Plate+frame 2x4M White	2x4	172 x 146
5/50	6 795 10	Plate+frame 9M White	9	288 X 86
10	6 795 12	Plate+frame 12M White	12	172 x 224
10	6 795 16	Plate+frame 16M White	16	172 x 224
10	6 795 18	Plate+frame 18M White	18	240 x 224

Pack	Cat.Nos	Plate Frame Ice White	No. of Modules	Dimension (mm)
1/5/30	6 795 21	Plate+frame 1M Ice White	1	86 x 86
1/5/30	6 795 22	Plate+frame 2M Ice White	2	86 x 86
1/20	6 795 23	Plate+frame 3M Ice White	3	86 x 121
1/20	6 795 24	Plate+frame 4M Ice White	4	86 x 146
1/10	6 795 26	Plate+frame 6M Ice White	6	86 x 224
1/10	6 795 28	Plate+frame 8M Ice White	8	86 x 245
1/5	6 795 29	Plate+frame 2x4M Ice White	2x4	172 x 146
1/5	6 795 32	Plate+frame 12M Ice White	12	172 x 224
1/5	6 795 36	Plate+frame 16M Ice White	16	172 x 224
1/5	6 795 38	Plate+frame 18M Ice White	18	240 x 224

Plates with frame

6 795 42

6 795 44



6 775 46

6 795 48



6 795 62

6 795 64



6 795 66

6 795 68

Pack	Cat.Nos	Plate Frame Ice Black	No. of Modules	Dimension (mm)
1/5/30	6 795 41	Plate+frame 1M Ice Black	1	86 x 86
1/5/30	6 795 42	Plate+frame 2M Ice Black	2	86 x 86
1/20	6 795 43	Plate+frame 3M Ice Black	3	86 x 121
1/20	6 795 44	Plate+frame 4M Ice Black	4	86 x 146
1/10	6 795 46	Plate+frame 6M Ice Black	6	86 x 224
1/10	6 795 48	Plate+frame 8M Ice Black	8	86 x 245
1/5	6 795 49	Plate+frame 2x4M Ice Black	2x4	172 x 146
1/5	6 795 52	Plate+frame 12M Ice Black	12	172 x 224
1/5	6 795 56	Plate+frame 16M Ice Black	16	172 x 224
1/5	6 795 58	Plate+frame 18M Ice Black	18	240 x 224

Pack	Cat.Nos	Plate Frame Pearl Champagne	No. of Modules	Dimension (mm)
1/5/30	6 795 61	Plate+frame 1M Pearl Champagne	1	86 x 86
1/5/30	6 795 62	Plate+frame 2M Pearl Champagne	2	86 x 86
1/20	6 795 63	Plate+frame 3M Pearl Champagne	3	86 x 121
1/20	6 795 64	Plate+frame 4M Pearl Champagne	4	86 x 146
1/10	6 795 66	Plate+frame 6M Pearl Champagne	6	86 x 224
1/10	6 795 68	Plate+frame 8M Pearl Champagne	8	86 x 245
1/5	6 795 69	Plate+frame 2x4M Pearl Champagne	2x4	172 x 146
1/5	6 795 72	Plate+frame 12M Pearl Champagne	12	172 x 224
1/5	6 795 76	Plate+frame 16M Pearl Champagne	16	172 x 224
1/5	6 795 78	Plate+frame 18M Pearl Champagne	18	240 x 224

Plates with Frame



6 795 82

6 795 84



6 795 86

6 795 88



6 796 02

6 796 04



6 796 06

6 796 08

Pack	Cat.Nos	Plate Frame Sonic Silver	No. of Modules	Dimension (mm)
1/5/30	6 795 81	Plate+frame 1M Sonic Silver	1	86 x 86
1/5/30	6 795 82	Plate+frame 2M Sonic Silver	2	86 x 86
1/20	6 795 83	Plate+frame 3M Sonic Silver	3	86 x 121
1/20	6 795 84	Plate+frame 4M Sonic Silver	4	86 x 146
1/10	6 795 86	Plate+frame 6M Sonic Silver	6	86 x 224
1/10	6 795 88	Plate+frame 8M Sonic Silver	8	86 x 245
1/5	6 795 89	Plate+frame 2x4M Sonic Silver	2x4	172 x 146
1/5	6 795 92	Plate+frame 12M Sonic Silver	12	172 x 224
1/5	6 795 96	Plate+frame 16M Sonic Silver	16	172 x 224
1/5	6 795 98	Plate+frame 18M Sonic Silver	18	240 x 224

Pack	Cat.Nos	Plate Frame Dark Fade	No. of Modules	Dimension (mm)
1/5/30	6 796 01	Plate+frame 1M Dark Fade	1	86 x 86
1/5/30	6 796 02	Plate+frame 2M Dark Fade	2	86 x 86
1/20	6 796 03	Plate+frame 3M Dark Fade	3	86 x 121
1/20	6 796 04	Plate+frame 4M Dark Fade	4	86 x 146
1/10	6 796 06	Plate+frame 6M Dark Fade	6	86 x 224
1/10	6 796 08	Plate+frame 8M Dark Fade	8	86 x 245
1/5	6 796 09	Plate+frame 2x4M Dark Fade	2x4	172 x 146
1/5	6 796 12	Plate+frame 12M Dark Fade	12	172 x 224
1/5	6 796 16	Plate+frame 16M Dark Fade	16	172 x 224
1/5	6 796 18	Plate+frame 18M Dark Fade	18	240 x 224

Plates with frame



6 796 22 6 796 24



6 796 42 6 796 44

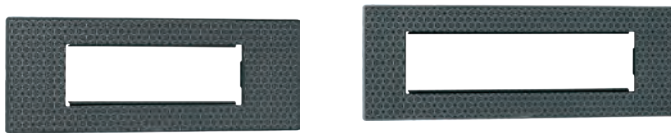

6 796 26 6 796 28

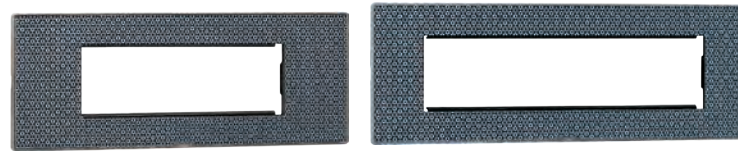

6 796 46 6 796 48

Pack	Cat.Nos	Plate Frame Interlude	No. of Modules	Dimension (mm)
1/5/30	6 796 21	Plate+frame 1M Interlude	1	86 x 86
1/5/30	6 796 22	Plate+frame 2M Interlude	2	86 x 86
1/20	6 796 23	Plate+frame 3M Interlude	3	86 x 121
1/20	6 796 24	Plate+frame 4M Interlude	4	86 x 146
1/10	6 796 26	Plate+frame 6M Interlude	6	86 x 224
1/10	6 796 28	Plate+frame 8M Interlude	8	86 x 245
1/5	6 796 29	Plate+frame 2x4M Interlude	2x4	172 x 146
1/5	6 796 32	Plate+frame 12M Interlude	12	172 x 224
1/5	6 796 36	Plate+frame 16M Interlude	16	172 x 224
1/5	6 796 38	Plate+frame 18M Interlude	18	240 x 224

Pack	Cat.Nos	Plate Frame Trinity	No. of Modules	Dimension (mm)
1/5/30	6 796 41	Plate+frame 1M Trinity	1	86 x 86
1/5/30	6 796 42	Plate+frame 2M Trinity	2	86 x 86
1/20	6 796 43	Plate+frame 3M Trinity	3	86 x 121
1/20	6 796 44	Plate+frame 4M Trinity	4	86 x 146
1/10	6 796 46	Plate+frame 6M Trinity	6	86 x 224
1/10	6 796 48	Plate+frame 8M Trinity	8	86 x 245
1/5	6 796 49	Plate+frame 2x4M Trinity	2x4	172 x 146
1/5	6 796 52	Plate+frame 12M Trinity	12	172 x 224
1/5	6 796 56	Plate+frame 16M Trinity	16	172 x 224
1/5	6 796 58	Plate+frame 18M Trinity	18	240 x 224

Plates with frame



6 796 62

6 796 64



6 796 82

6 796 84



6 796 66

6 796 68

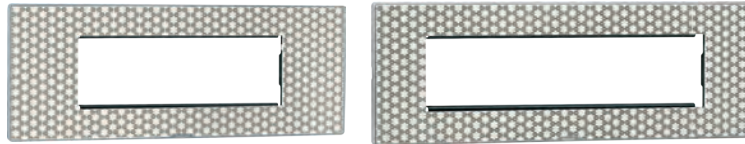

6 796 86

6 796 88

Pack	Cat.Nos	Plate Frame Luminar	No. of Modules	Dimension (mm)
1/5/30	6 796 61	Plate+frame 1M Luminar	1	86 x 86
1/5/30	6 796 62	Plate+frame 2M Luminar	2	86 x 86
1/20	6 796 63	Plate+frame 3M Luminar	3	86 x 121
1/20	6 796 64	Plate+frame 4M Luminar	4	86 x 146
1/10	6 796 66	Plate+frame 6M Luminar	6	86 x 224
1/10	6 796 68	Plate+frame 8M Luminar	8	86 x 245
1/5	6 796 69	Plate+frame 2x4M Luminar	2x4	172 x 146
1/5	6 796 72	Plate+frame 12M Luminar	12	172 x 224
1/5	6 796 76	Plate+frame 16M Luminar	16	172 x 224
1/5	6 796 78	Plate+frame 18M Luminar	18	240 x 224

Pack	Cat.Nos	Plate Frame Stellar	No. of Modules	Dimension (mm)
1/5/30	6 796 81	Plate+frame 1M Stellar	1	86 x 86
1/5/30	6 796 82	Plate+frame 2M Stellar	2	86 x 86
1/20	6 796 83	Plate+frame 3M Stellar	3	86 x 121
1/20	6 796 84	Plate+frame 4M Stellar	4	86 x 146
1/10	6 796 86	Plate+frame 6M Stellar	6	86 x 224
1/10	6 796 88	Plate+frame 8M Stellar	8	86 x 245
1/5	6 796 89	Plate+frame 2x4M Stellar	2x4	172 x 146
1/5	6 796 92	Plate+frame 12M Stellar	12	172 x 224
1/5	6 796 96	Plate+frame 16M Stellar	16	172 x 224
1/5	6 796 98	Plate+frame 18M Stellar	18	240 x 224

Plates with frame (antibacterial range)



6 793 42













6 793 44



6 793 46



6 793 48

Pack	Cat.Nos	Plate Frame Anti-Bacterial	No. of Modules	Dimension (mm)
20/200	6 793 41	 Plate+frame 1M Anti-Bacterial	1	86 x 86
20/200	6 793 42	 Plate+frame 2M Anti-Bacterial	2	86 x 86
10/100	6 793 43	 Plate+frame 3M Anti-Bacterial	3	86 x 121
10/100	6 793 44	 Plate+frame 4M Anti-Bacterial	4	86 x 146
5/50	6 793 46	 Plate+frame 6M Anti-Bacterial	6	86 x 224
5/50	6 793 48	 Plate+frame 8M Anti-Bacterial	8	86 x 245
5/25	6 793 49	 Plate+frame 2x4M Anti-Bacterial	2x4	172 x 146
5/50	6 793 50	 Plate+frame 9M Anti-Bacterial	9	288 X 86
10	6 793 52	 Plate+frame 12M Anti-Bacterial	12	172 x 224
10	6 793 56	 Plate+frame 16M Anti-Bacterial	16	172 x 224
10	6 793 58	 Plate+frame 18M Anti-Bacterial	18	240 x 224

Mounting Boxes



Pack	Cat.Nos	Metal Flush Boxes	
40	6 890 07		Flush Box - 1/2 Module
40	6 890 08		Flush Box - 3 Module
40	6 890 09		Flush Box - 4 Module
40	6 890 10		Flush Box - 6 Module
40	6 890 42		Flush Box - 8 Module
20	6 890 31		Flush Box - 8 Module (2 row x 4)
10	6 890 11		Flush Box - 12/16 (2 row x 6) Module
10	6 890 12		Flush Box - 18 Module

No. of Modules

1/2

3

4

6

8

8

12/16

18

Plastic and metal surface boxes



Pack	Cat.Nos	Plastic Surface Boxes	
10/50	6 733 02		Surface Box - 1/2 Module
5/35	6 733 03		Surface Box - 3 Module
5/25	6 733 04		Surface Box - 4 Module
1/10	6 733 06		Surface Box - 6 Module
1/5	6 733 08		Surface Box - 8 Module
1/5	6 733 05		Surface Box - 8 (2 row x 4) Module
1/6	6 890 21		Surface Box - 12/16 (2 row x 6) Module
1/4	6 890 22		Surface Box - 18 Module

No. of Modules

1/2

3

4

6

8

8

12/16





18



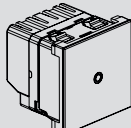











Metal Surface Boxes

Technical data
6A touch switch 2M-1W

Cat.No 6 793 09

Characteristics

 -5 °C ..+45 °C	 -1 °C ..+70 °C	 ≤ 40 mm	100 - 240 V~ 50 / 60 Hz	 1...4 mm ²
--	--	---	----------------------------	---

	1	2	3	4	5	6	7
							
							
240V~	1440W	1000V AC	1000V AC	250W	250W	250W	4A(PF≥0.6)
100V~	600W	400V AC	400V AC	100W	100W	100W	

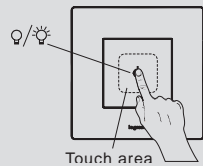
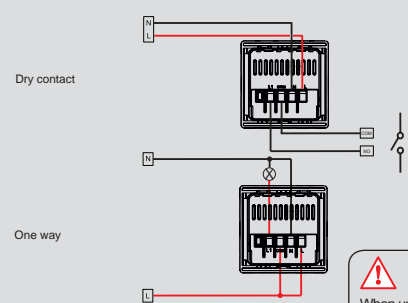
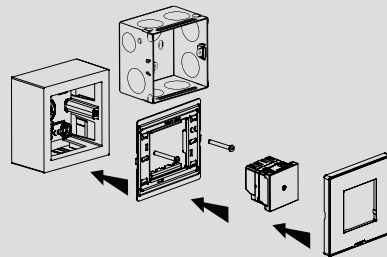
Operation

Wiring

Fixing

 **Safety instructions**



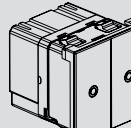

When use this product, please install a fuse or protective device to protect the product in the line of COM input, the protective device should be equal to 6 A / 100-240 V.















This product should be installed preferably by a qualified electrician. Incorrect installation and use can entail risk of electric shock or fire. Before carrying out the installation, read the instructions and take account of the product's specific mounting location. Do not open up the device. All Legrand products must be exclusively opened and repaired by personnel trained and approved by LEGRAND. Any unauthorized opening or repair completely cancels all liabilities and the rights to replacement and guarantees. Only use genuine accessories.

Technical data
Electronic switch 6A touch 2M 1W-2-SW control

Cat.No 6 793 08

Characteristics

 0 °C/+45 °C	 -10 °C/+70 °C	 40 mm	100-240 V~ 50/60 Hz	 1-4 mm ²
---	---	---	------------------------	---

	①	②	③	④	⑤	⑥	⑦
							
							
240 V ~	1000W	700 V AC	700 V AC	250W	250W	250W	4A(FP=0.6)
100 V ~	400W	300 V AC	300 V AC	100W	100W	100W	

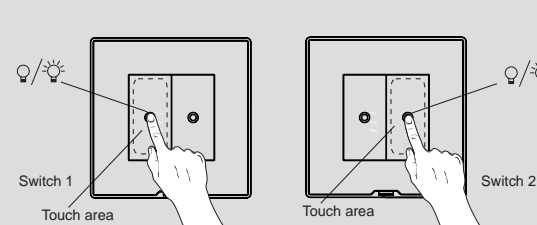
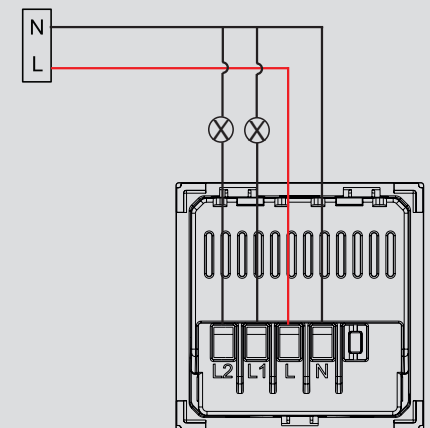
Operation

Wiring

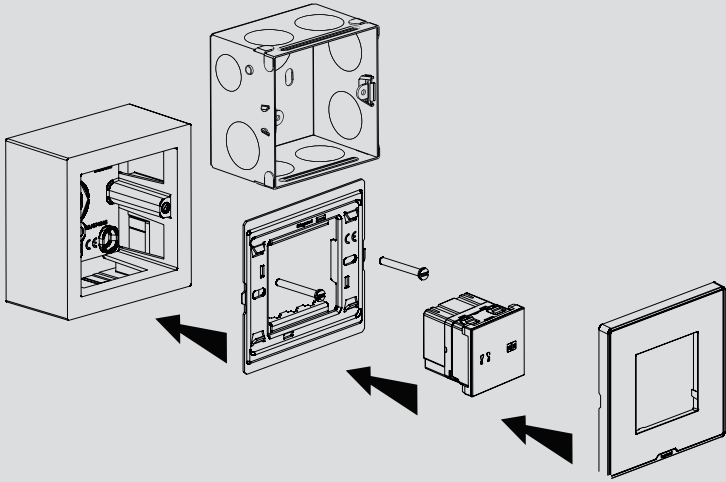
Fixing



⚠ Safety instructions

When use this product, please install a fuse or protective device to protect the product in the line of COM input, the protective device should be equal to 6 A / 100-240 V.
This product should be installed preferably by a qualified electrician. Incorrect installation and use can entail risk of electric shock or fire. Before carrying out the installation, read the instructions and take account of the product's specific mounting location. Do not open up the device. All Legrand products must be exclusively opened and repaired by personnel trained and approved by LEGRAND. Any unauthorized opening or repair completely cancels all liabilities and the rights to replacement and guarantees. Only use genuine accessories.

■ Technical data

6A touch switch 2M-2W

Cat.No 6 793 10

Characteristics

				100 - 240 V~		
	-5 °C/+45 °C	-10 °C/+70 °C	≤ 40 mm	50 / 60 Hz	1...4 mm ²	
1	2	3	4	5	6	7
240V~	1000W	700V AC	700V AC	250W	250W	250W
100V~	400W	300V AC	300V AC	100W	100W	100W
						4A(PF≥0.6)

Operation

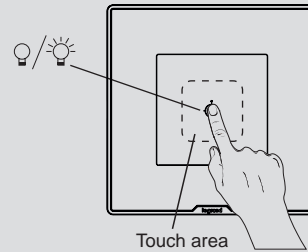

Wiring

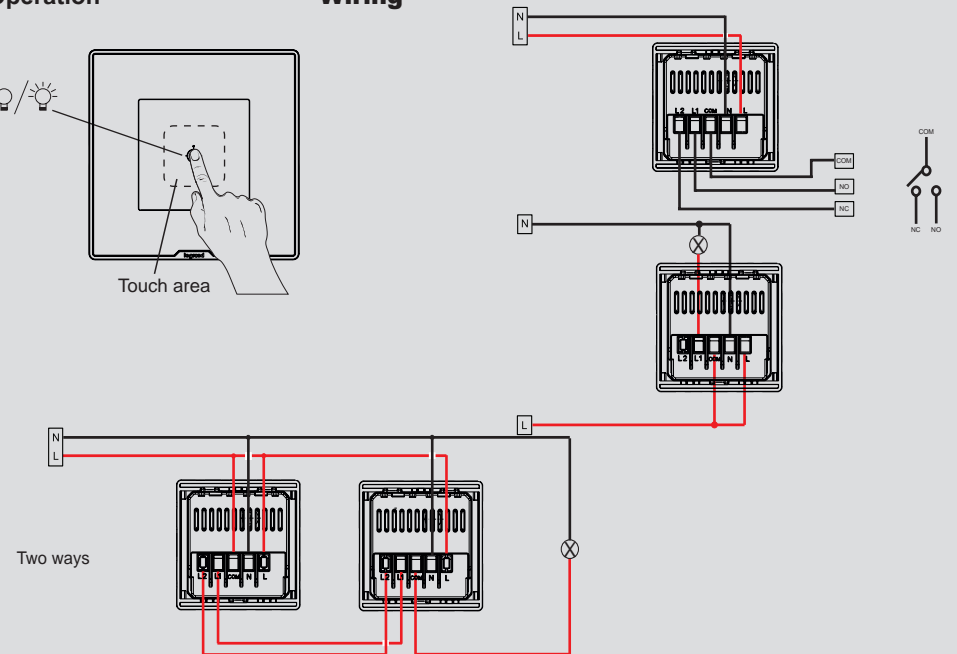

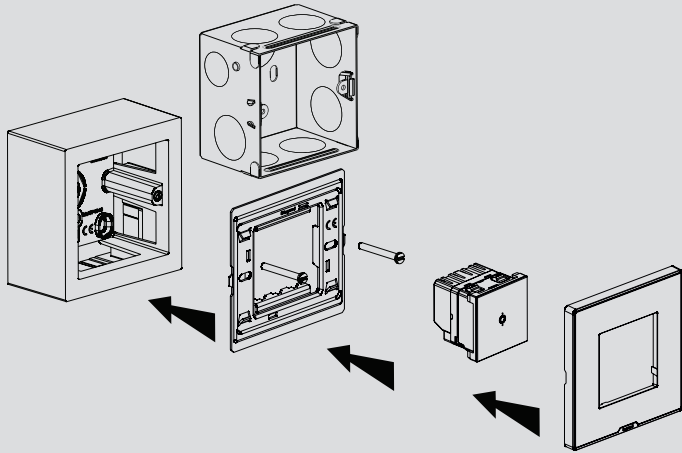
Fixing

Safety instructions

When use this product, please install a fuse or protective device to protect the product in the line of COM input, the protective device should be equal to 6 A / 100~240 V.

This product should be installed preferably by a qualified electrician. Incorrect installation and use can entail risk of electric shock or fire.

Before carrying out the installation, read the instructions and take account of the product's specific mounting location.

Do not open up the device. All Legrand products must be exclusively opened and repaired by personnel trained and approved by LEGRAND.

Any unauthorized opening or repair completely cancels all liabilities and the rights to replacement and guarantees.

Only use genuine accessories.

Technical data
16A touch switch 2M-1W

Cat.No 6 793 13

Characteristics

			100 - 240 V~ 50 / 60 Hz	
-5 °C.../+45 °C	-10 °C.../+70 °C	≤ 40 mm		1...4 mm ²

	1	2	3	4	5	6	7
240V~	3000W	2000V AC	2000V AC	600W	600W	500W	8A(PF≥0.6)
100V~	1250W	800V AC	800V AC	250W	250W	300W	

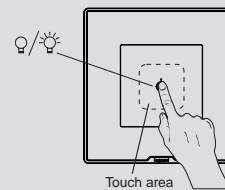
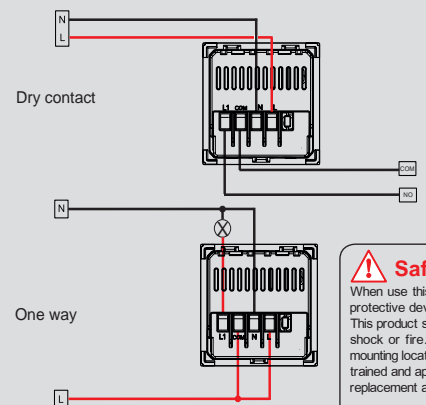
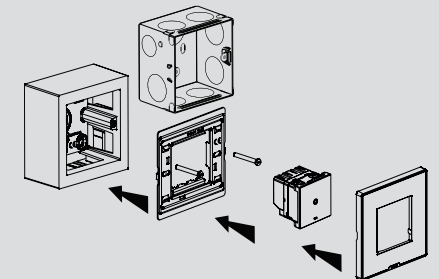
Operation

Wiring

Fixing

Safety instructions

When use this product, please install a fuse or protective device to protect the product in the line of COM input, the protective device should be equal to 6 A / 100~240 V.

This product should be installed preferably by a qualified electrician. Incorrect installation and use can entail risk of electric shock or fire. Before carrying out the installation, read the instructions and take account of the product's specific mounting location. Do not open up the device. All Legrand products must be exclusively opened and repaired by personnel trained and approved by LEGRAND. Any unauthorized opening or repair completely cancels all liabilities and the rights to replacement and guarantees. Only use genuine accessories.

6 A touch switch Bell Push 2M
Technical data
6A touch switch Bell Push 2M

Cat.No 6 793 06

Characteristics

-5 °C/+45 °C -10 °C/+70 °C ≤ 40 mm 100 - 240 V~
 50 / 60 Hz 1...4 mm²

	1	2	3	4
240V~	1440W	200W	200W	200W
100V~	600W	100W	100W	100W

- 1 Incandescent lamp
- 2 Electronic triggered with tunes
- 3 Electric magnetic tong bell (ding dong)
- 4 Electric Buzzer-Vibrating

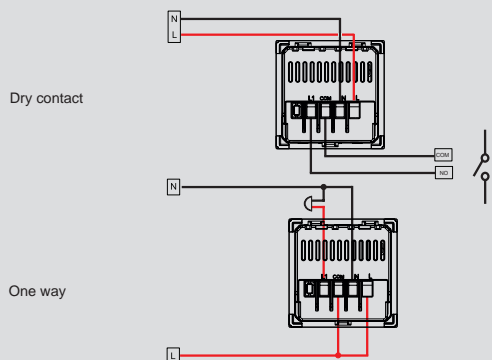
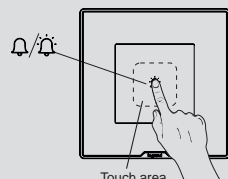
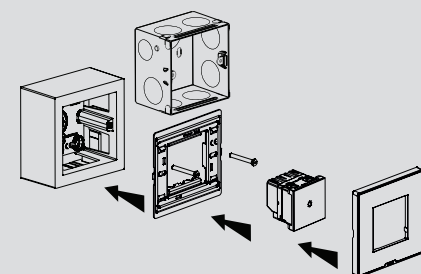
Wiring

Operation

Fixing

Safety instructions

When use this product, please install a fuse or protective device to protect the product in the line of COM input, the protective device should be equal to 6 A / 100~240 V.

This product should be installed preferably by a qualified electrician. Incorrect installation and use can entail risk of electric shock or fire. Before carrying out the installation, read the instructions and take account of the product's specific mounting location. Do not open up the device. All Legrand products must be exclusively opened and repaired by personnel trained and approved by LEGRAND. Any unauthorized opening or repair completely cancels all liabilities and the rights to replacement and guarantees. Only use genuine accessories.

300 W universal LED touch dimmer 2M
Technical data
300W universal LED touch dimmer 2M

Cat.No 6 793 15

Characteristics

-5 °C.../+45 °C -10 °C.../+70 °C ≤ 40 mm 100 - 240 V~
 50 / 60 Hz 1...4 mm²

	R	L	C/L		
	Dimmable				
240V~ 50Hz	5...300W	5... 300V AC	5... 300V AC	5... 300V AC	5...75W ≤ 10 x
100V~ 60Hz	5...150W	5... 150V AC	5... 150V AC	5... 150V AC	5...37W ≤ 10 x

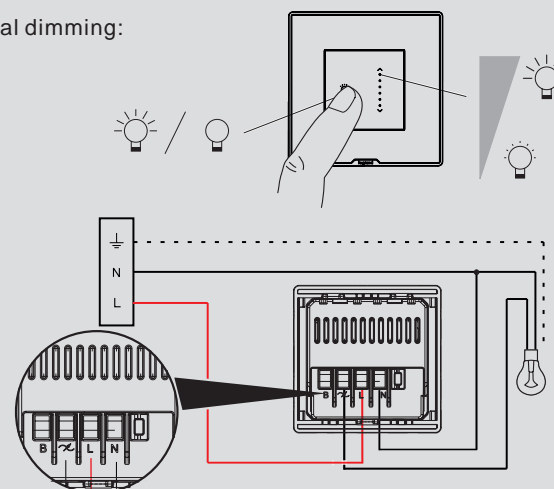
Local dimming:

300 W universal LED touch dimmer 2M (contd.)

■ Technical data

300 W Universal LED touch dimmer - 2M

Cat.No 6 793 15

Characteristics

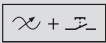

Local+remote/auxiliary dimming:

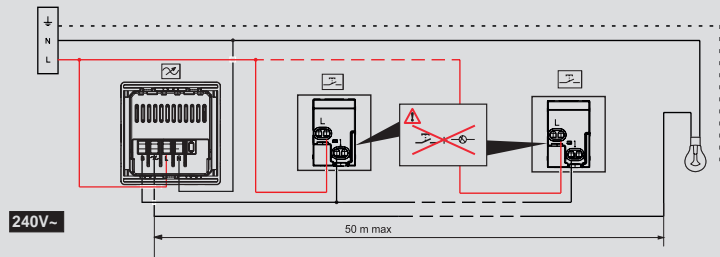
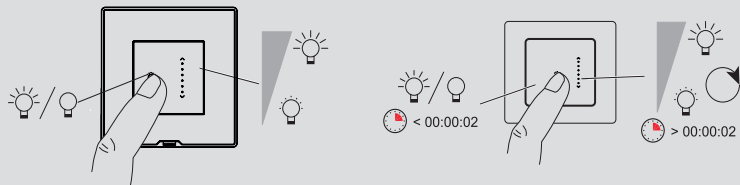

Min. brightness settings

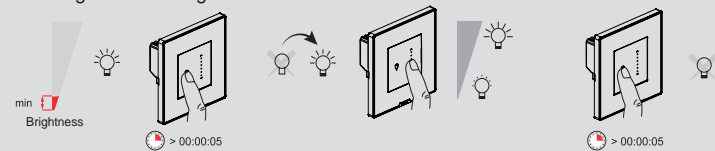

CFL setting

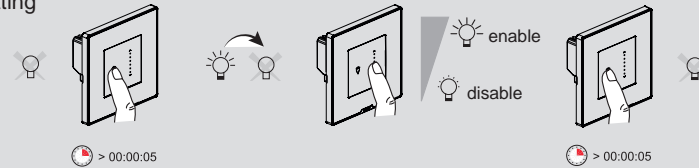

Load type setting

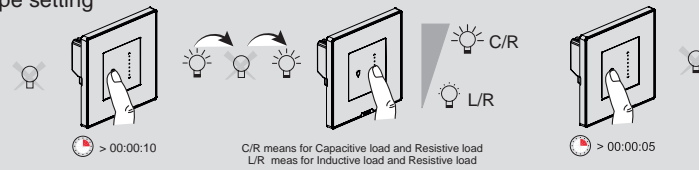

Fixing

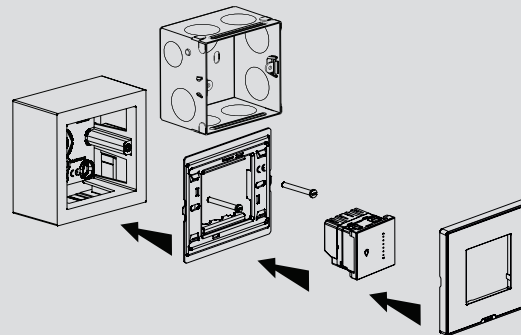

⚠ Safety instructions

This product should be installed preferably by a qualified electrician. Incorrect installation and use can entail risk of electric shock or fire. Before carrying out the installation, read the instructions and take account of the product's specific mounting location. Do not open up the device. All Legrand products must be exclusively opened and repaired by personnel trained and approved by LEGRAND. Any unauthorized opening or repair completely cancels all liabilities and the rights to replacement and guarantees. Only use genuine accessories.

■ Technical data

Touch Fan regulator 2M-100W

Cat.No 6 793 05

Characteristics

			240V~ 50HZ	
-5°C...+45 °C	-10°C...+70 °C	≤ 40 mm		1...2.5mm ²

①	
240~50HZ	100W

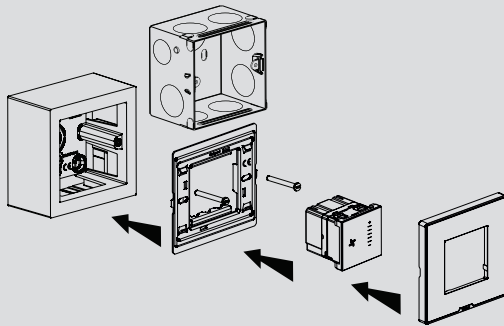
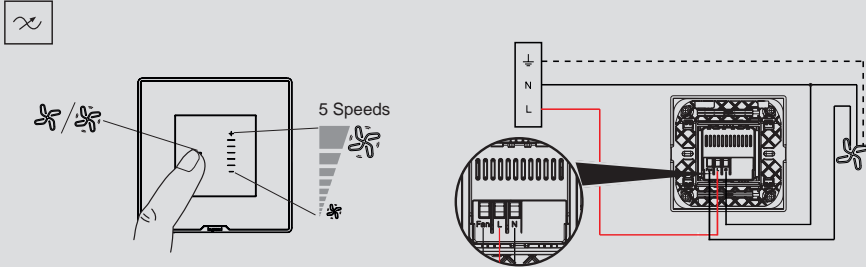

Safety instructions

This product should be installed preferably by a qualified electrician. Incorrect installation and use can entail risk of electric shock or fire. Before carrying out the installation, read the instructions and take account of the product's specific mounting location. Do not open up the device. All Legrand products must be exclusively opened and repaired by personnel trained and approved by LEGRAND. Any unauthorized opening or repair completely cancels all liabilities and the rights to replacement and guarantees. Only use genuine accessories.

■ Technical data

Electronic switch touch- curtain controller 2M

Cat.No 6 793 07

Characteristics

			100-240 V~	
0 °C/+45 °C	-10 °C/+70 °C	50 mm	50/60 Hz	1-4 mm ²

①	
240 V~	200V AC
100 V~	100 V AC

Operation

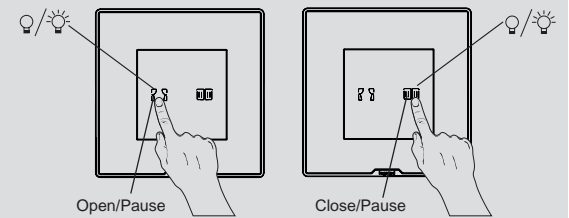

Wiring

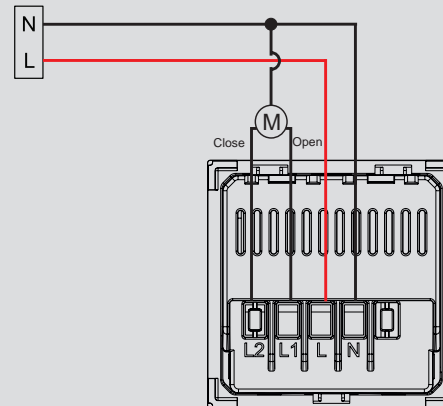

Fixing

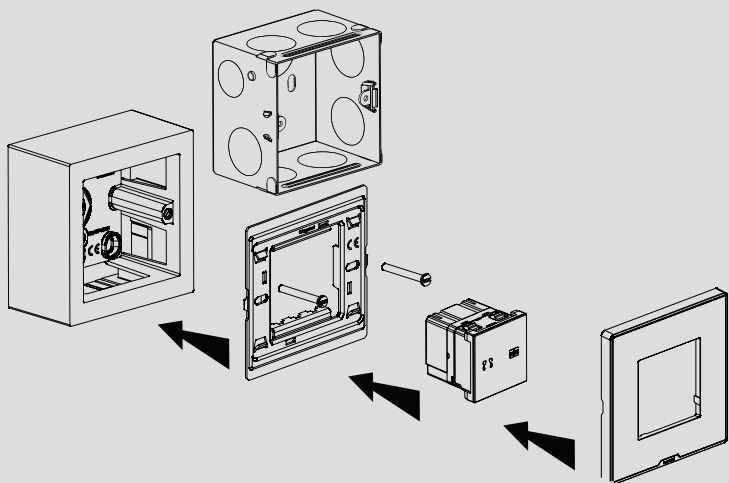

Safety instructions

When use this product, please install a fuse or protective device to protect the product in the line of COM input, the protective device should be equal to 6 A / 100-240 V.
This product should be installed preferably by a qualified electrician. Incorrect installation and use can entail risk of electric shock or fire. Before carrying out the installation, read the instructions and take account of the product's specific mounting location. Do not open up the device. All Legrand products must be exclusively opened and repaired by personnel trained and approved by LEGRAND. Any unauthorized opening or repair completely cancels all liabilities and the rights to replacement and guarantees. Only use genuine accessories.

Technical data

Bluetooth Sound Receiver

Cat.Nos 6 792 99 / 6 794 97

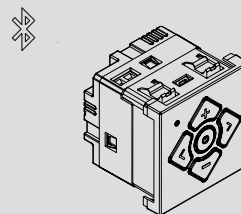

Utilization

			Bluetooth (A2DP)		Works with Bluetooth technology devices
100-240V AC	STEREO 2X1.5 W	4 mA Max AC	> 8 m	40° 0° +5 °C +45 °C	

Bluetooth device Name - "legrand"

Wiring

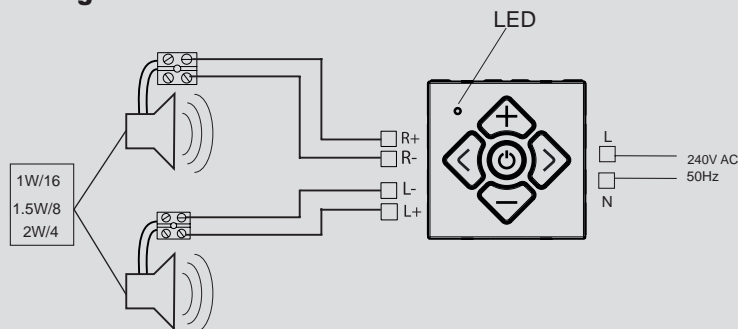

Function

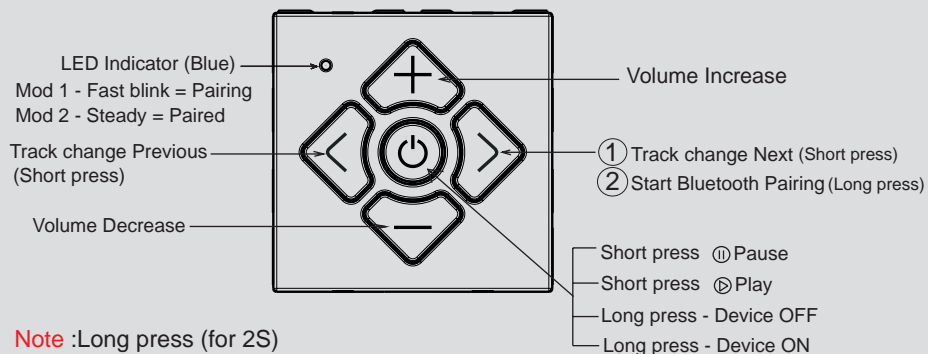

■ Technical data

Bluetooth Connection

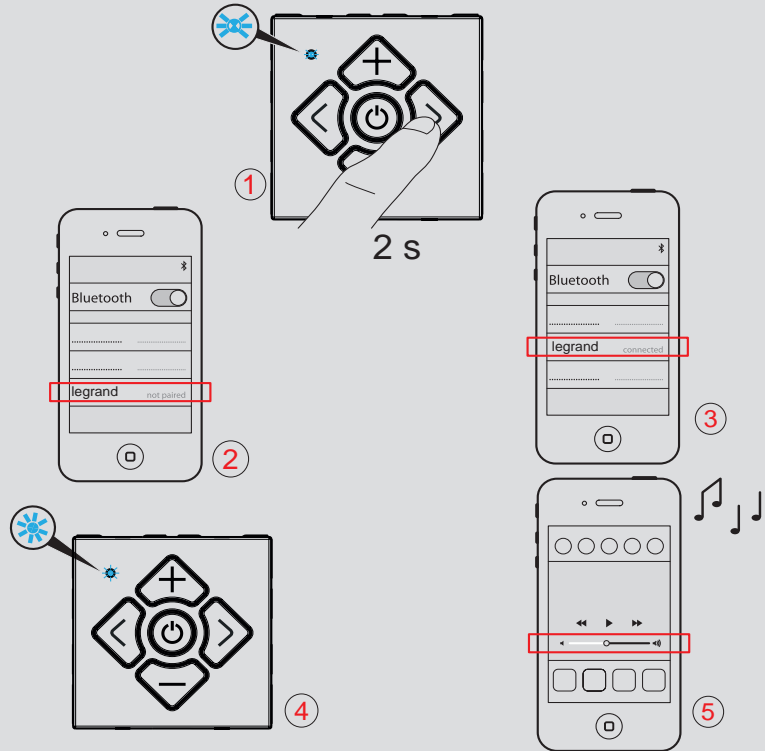

Mounting

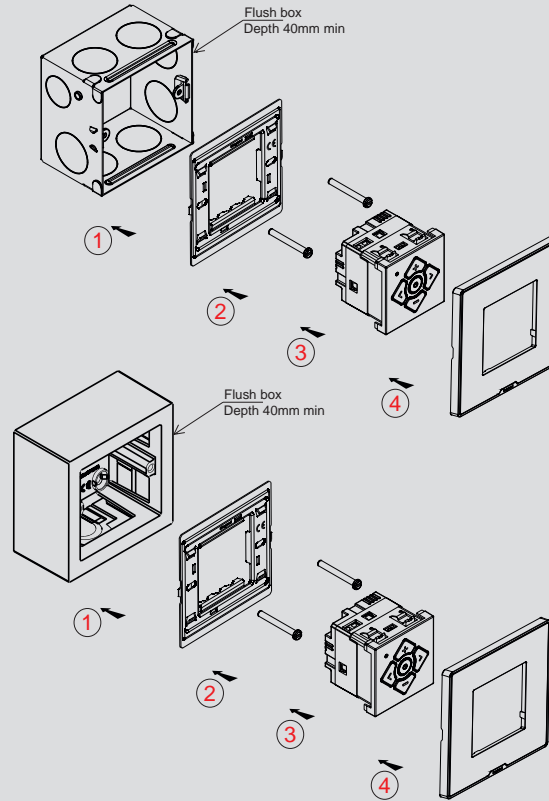

Safety instructions

GB 1E

This product should be installed in line with installation rules, preferably by a qualified electrician. Incorrect installation and use can lead to risk of electric shock or fire. Before carrying out the installation, read the instructions and take account of the product's specific mounting location.

Do not open up, dismantle, alter or modify the device except where specifically required to do so by the instructions. All Legrand products must be opened and repaired exclusively by personnel trained and approved by LEGRAND. Any unauthorized opening or repair completely cancels all liabilities and the rights to replacement and guarantees.

Use only Legrand brand accessories.

Remote for Fan and Light mechanism

Technical data

Remote for Fan and Light mechanism

Cat.Nos 6 794 52 / 6 792 52

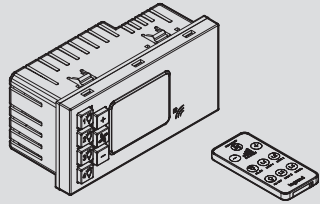

40° 0°	①	②	③	④	⑤	⑥
240 V AC 50 Hz						
Max.	1x2.5 mm ²	400V AC	200V AC	200V AC	150V AC	100V AC
				Ø26 Ø38		

Utilization

- 1. Incandescent bulbs
- 2. Halogen lamp 230V~
- 3. Low voltage halogen lamps
- 4. Fluorescent tube light
- 5. Ceiling Fan (OFF + 4 Variable speed steps)
- 6. LED Lamps (Max 3 Units)

Description

Infrared receiver and controller unit

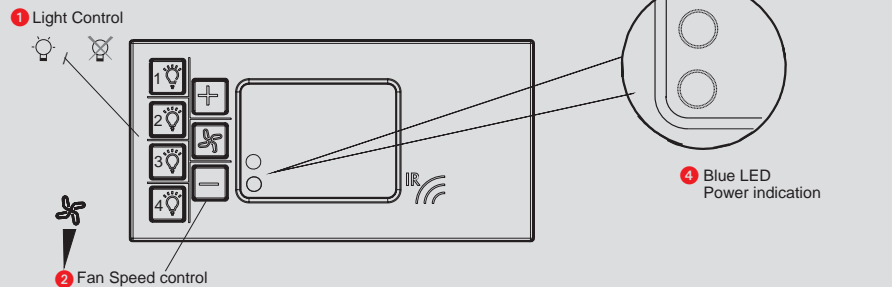

Infrared remote transmitter

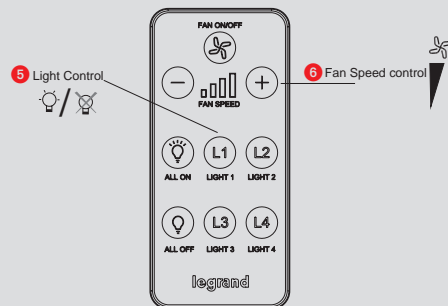

Wiring diagram

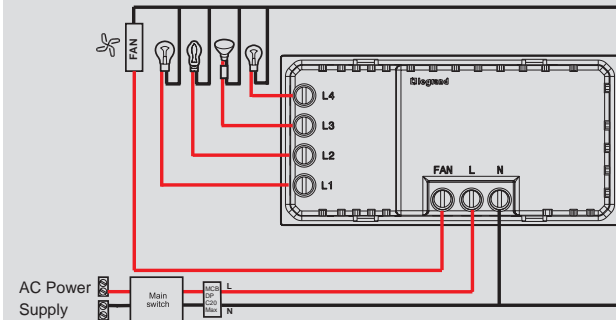

Replacement of old battery

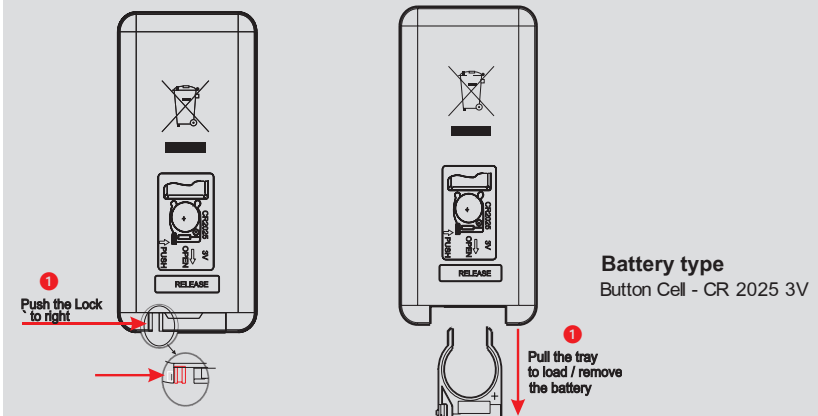

⚠ Safety instructions

This product should be installed in line with installation rules, preferably by a qualified electrician. Incorrect installation and use can lead to risk of electric shock or fire. Before carrying out the installation, read the instructions and take account of the product's specific mounting location. Do not open up, dismantle, alter or modify the device except where specifically required to do so by the instructions. All Legrand products must be opened and repaired exclusively by personnel trained and approved by LEGRAND. Any unauthorised opening or repair completely cancels all liabilities and the rights to replacement and guarantees. Use only Legrand brand accessories.

■ Technical data

Rotary LED dimmer 1M

Cat.Nos 6 793 04 / 6 794 98

Characteristics

	0° C ... +45° C	-10° C ... +70° C	≤ 40 mm	100 - 240 V~ 50 / 60 Hz	1 x 2.5 mm ²

						Dimmable 	Dimmable 	Dimmable 	Dimmable LED
240 V	Max.	200W	200W	200V AC	200V AC	200V AC	200V AC	50W or 8 lamps max.	50W or 8 lamps max.
	Min.	3W	3W	3V AC	3V AC	3V AC	3V AC	3W	3W
100 V	Max.	100W	100W	100V AC	100V AC	100V AC	100V AC	37W or 8 lamps max.	37W or 8 lamps max.
	Min.	3W	3W	3V AC	3V AC	3V AC	3V AC	3W	3W

Operation

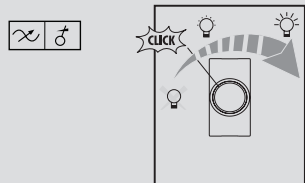

Wiring

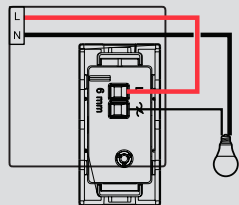

Fixing

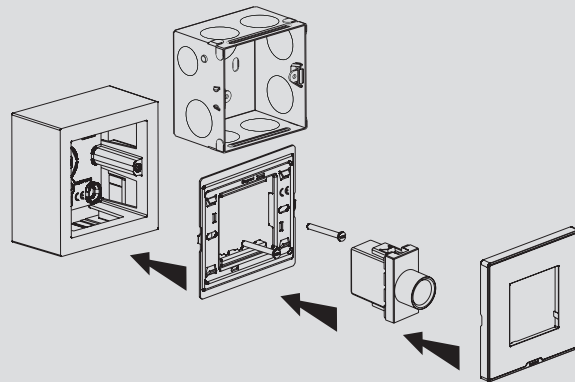

⚠ Safety instructions

This product should be installed preferably by a qualified electrician. Incorrect installation and use can entail risk of electric shock or fire. Before carrying out the installation, read the instructions and take account of the product's specific mounting location. Do not open up the device. All Legrand products must be exclusively opened and repaired by personnel trained and approved by LEGRAND. Any unauthorized opening or repair completely cancels all liabilities and the rights to replacement and guarantees. Only use genuine accessories.

■ Technical data

Wireless induction charger

Cat.No 6 792 95

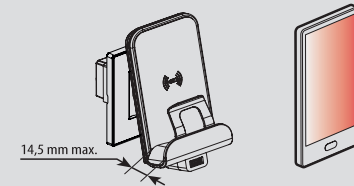
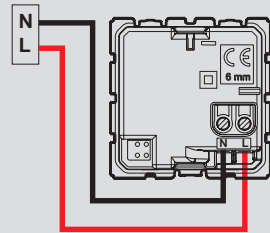
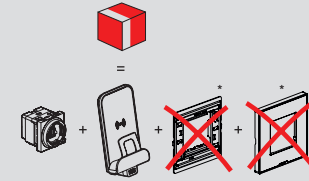
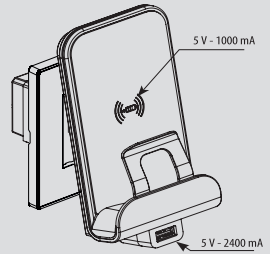

Wireless charging only with compatible mobile phones having induction receiver technology.

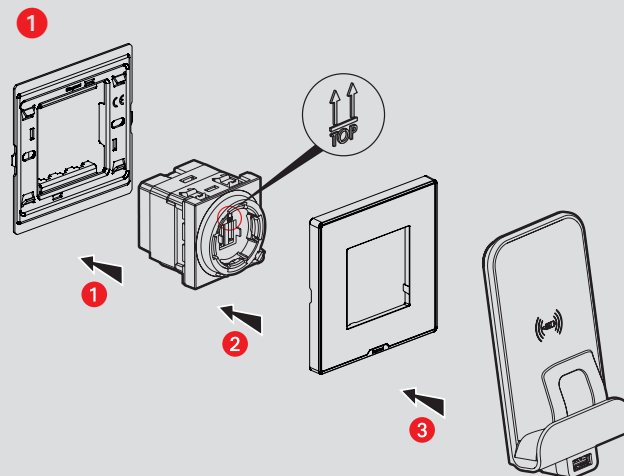

■ Technical data

Wireless charger (contd.)

Cat.No 6 792 95

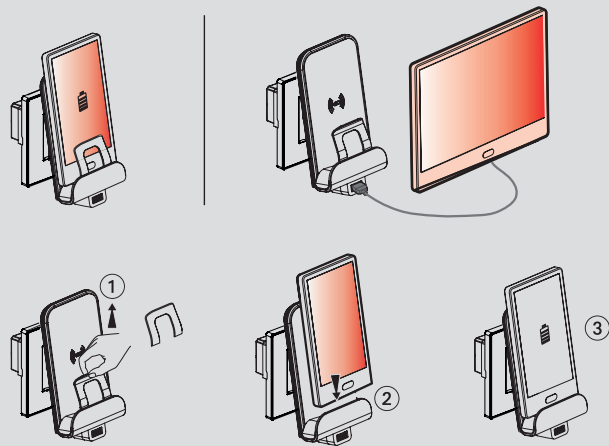
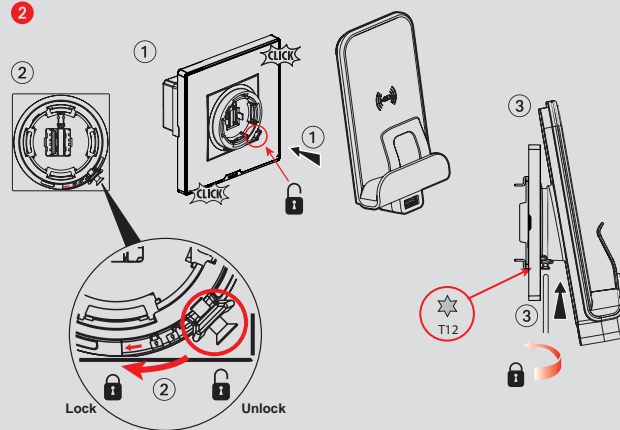

⚠ Safety instructions

This product should be installed in compliance with installation rules, preferably by a qualified electrician. Incorrect installation and/or incorrect use can lead to risk of electric shock or fire. Before carrying out the installation, read the instructions and take account of the product's specific mounting location.
Do not open up, dismantle, alter or modify the device except where specifically required to do so by the instructions. All Legrand products must be opened and repaired exclusively by personnel trained and approved by Legrand. Any unauthorised opening or repair completely cancels all liabilities and the rights to replacement and guarantees. Use only Legrand brand accessories.

■ Technical data

Infrared sensor switch

Cat.No 6 792 51

Characteristics

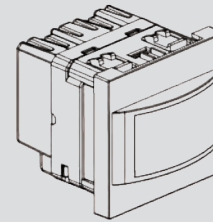

-5 °C/+45 °C	-10 °C/+70 °C	40 mm	100 - 240 V- 50 / 60 Hz	1-4 mm ²
PIR	day/dusk/night	30S/90S/180S	40 m ²	

	①	②	③	④	⑤	⑥	⑦
230 V~	400W	200V AC	200V AC	200V AC	200V AC	100V AC	100V AC
110 V~	200W	1.7 A	100V AC	100V AC	100V AC	50V AC	50V AC
		0.85 A	0.85 A	0.85A	0.85A	0.42A	0.42A

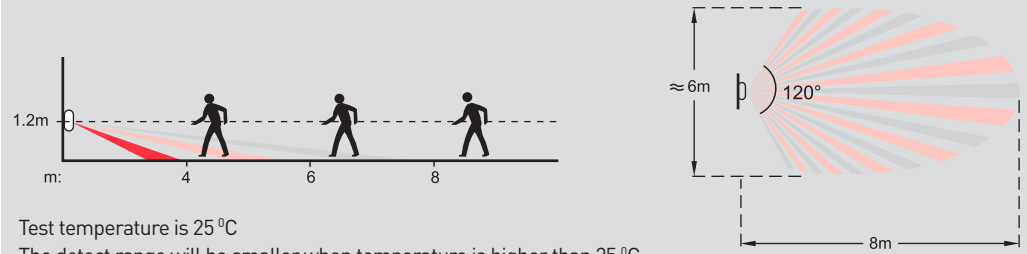

Test temperature is 25 °C
The detect range will be smaller when temperature is higher than 25 °C

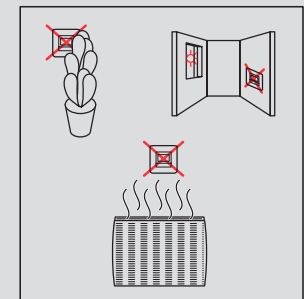
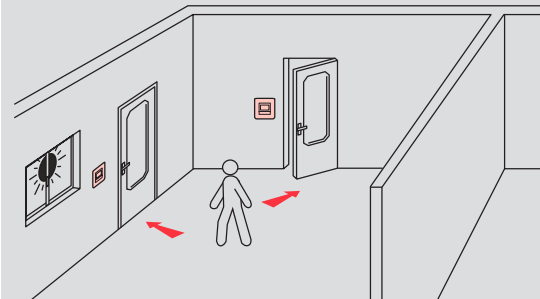

Wiring

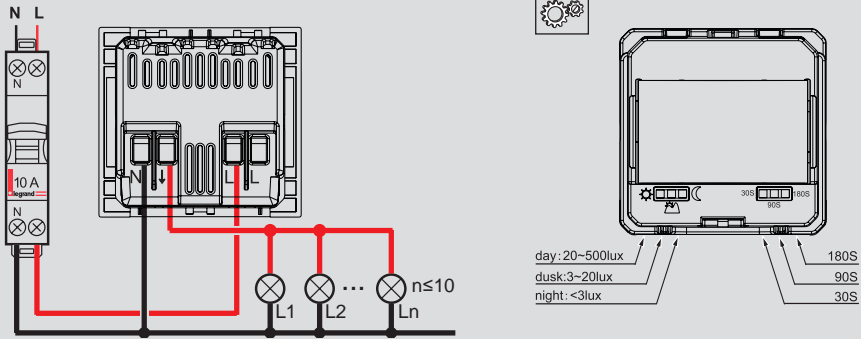

Working

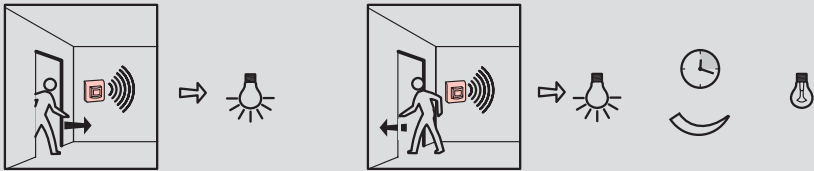

* A delay of 1min to be observed after power ON for functioning of the switch.

Fixing

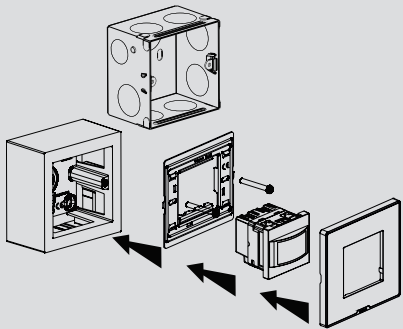

⚠ Safety instructions

This product should be installed preferably by a qualified electrician. Incorrect installation and use can entail risk of electric shock or fire. Before carrying out the installation, read the instructions and take account of the product's specific mounting location. Do not open up the device. All Legrand products must be exclusively opened and repaired by personnel trained and approved by LEGRAND. Any unauthorized opening or repair completely cancels all liabilities and the rights to replacement and guarantees. Only use genuine accessories.

Technical data

16A Hotel Key FOB switch

Cat.Nos 6 792 53

Characteristics

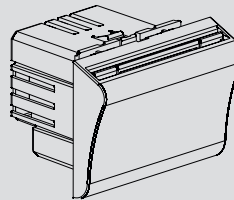

	16A max
	16 A / 230 V-μ cosφ = 1
	4 A / 230 V-μ cosφ = 0.6

Utilization

 40° 0° 230 V- 50 Hz	 1800W	 800W	 400V AC	 800V AC	 100V AC
Max.	1800W	800W	400V AC	800V AC	100V AC

- 1800 W lamp incandescent or halogen with ferromagnetic transformer.
- 800 W inductive (motor).
- 400 VA compensated fluorescent lamp.
- 800 VA fluorescent lamp with electronic ballast.
- 100 VA LED lamp.

Important: For load higher than indicated in the above table, use a contactor.

Installation

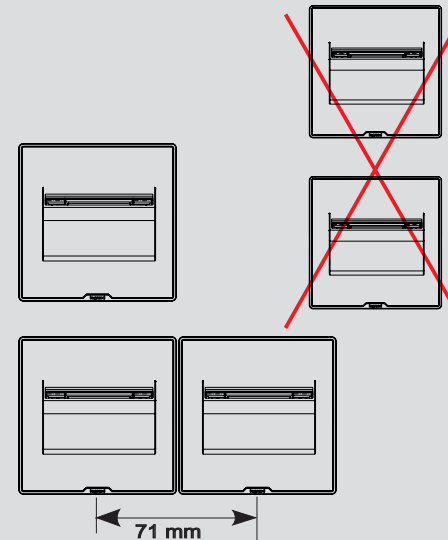

Wiring

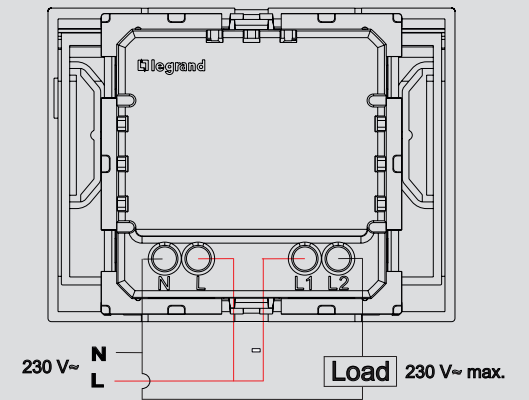

Shaver Socket

Fixing

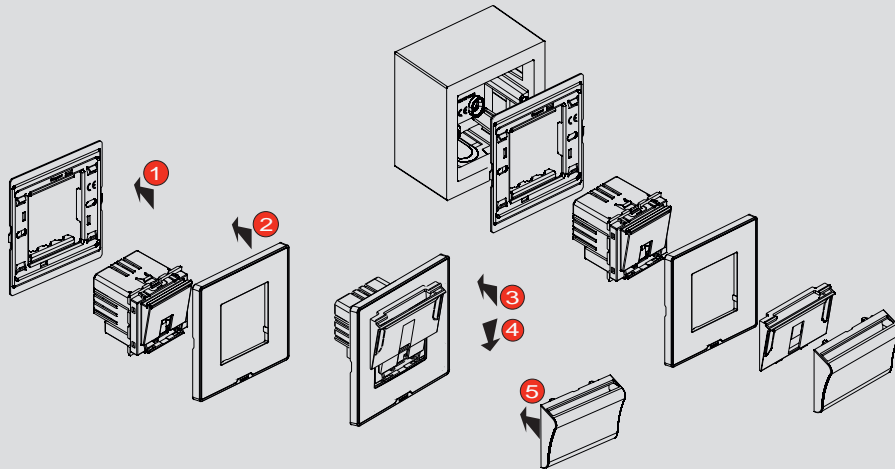

Use

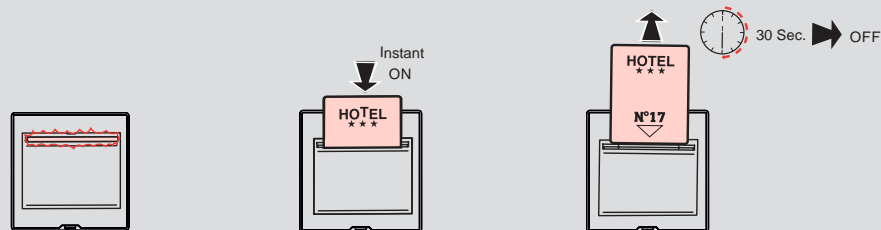

Dismantling / Maintenance

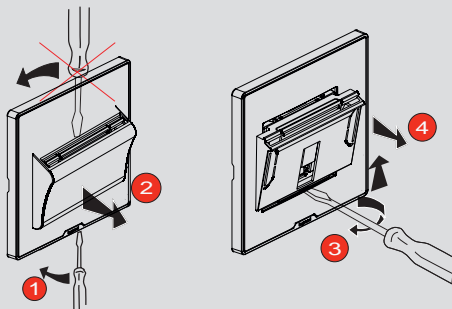

⚠ Safety instructions

This product should be installed in compliance with installation rules, preferably by a qualified electrician. Incorrect installation and use can lead to risk of electric shock or fire. Before carrying out the installation, read the instructions and take account of the product's specific mounting location.

Do not open up, dismantle, alter or modify the device except where specifically required to do so by the instructions. All Legrand products must be opened and repaired exclusively by personnel trained and approved by Legrand. Any unauthorised opening or repair completely cancels all liabilities and the rights to replacement and guarantees.

Use only Legrand brand accessories.

Technical data

Shaver Socket

Cat.Nos 6 792 58

Characteristics

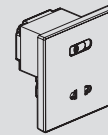

0°C/+45°C	-10°C/+70°C	≥ 50 mm	230 V~ 50/60 Hz	1~4 mm ²
-----------	-------------	---------	--------------------	---------------------

Application

This product will be used in hotel, it can provide safe power for electric shavers. The standby power is 0W, no plug in no output power (please take care, this output to be used for electric shavers only.)

Technical partmeter

Input: 230V ~ 50/60 Hz

Output: 230V~50/60 Hz or 115V ~ 50/60 Hz

Operation

Slide switch configuration

1. Switch set to 115 V~, output is 115 V AC.
2. Switch set to 230 V~, output is 230 V AC.

Caution

1. Do not use for other application, except shaver.
2. Before plug in the shaver socket, please confirm the voltage of your product, set the right voltage 115V or 230V.

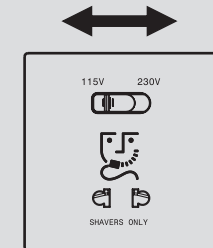

Wiring

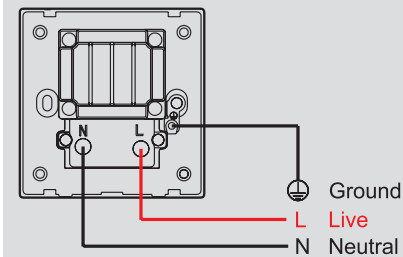

Fixing

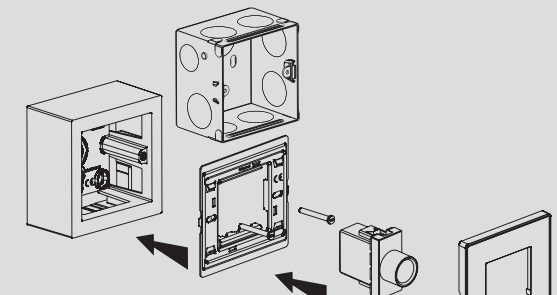

⚠ Safety instructions

This product should be installed preferably by a qualified electrician. Incorrect installation and use can entail risk of electric shock or fire. Before carrying out the installation, read the instructions and take account of the product's specific mounting location. Do not open up the device. All Legrand products must be exclusively opened and repaired by personnel trained and approved by LEGRAND. Any unauthorised opening or repair completely cancels all liabilities and the rights to replacement and guarantees. Only use genuine accessories.

■ Technical data

DND & CMR Internal and External Unit

Cat.Nos 6 792 57 / 6 794 55
6 792 56 / 6 794 54



Characteristics

oltage			Audible signal 6 792 50 - 6 794 50
230 V~ 50Hz	2 x 2.5 mm ²	- 5° C + 40° C	230 V~ 70 - 90 dB

Description

Call indicator
6 792 56 / 6 794 54

(A) (B)

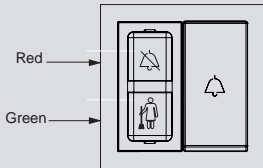

Call control
6 792 57 / 6 794 55

(C) (D)



Option

Buzzer

(E)



Wiring

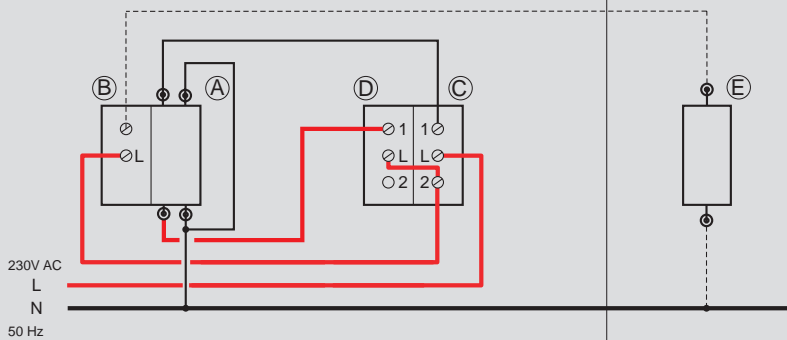

Assembly
Internal Unit

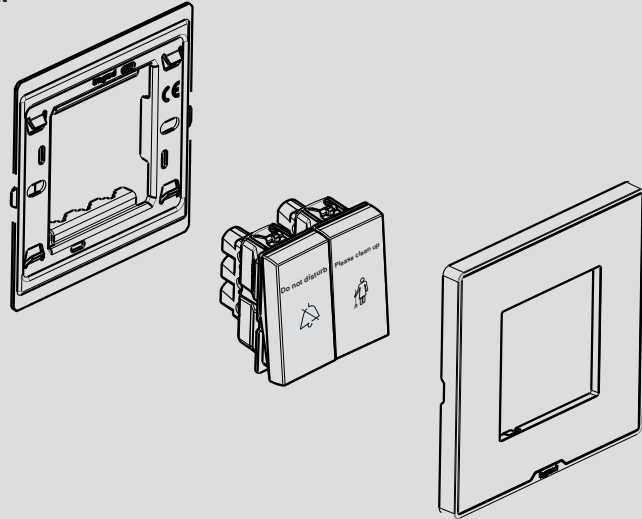

External Unit

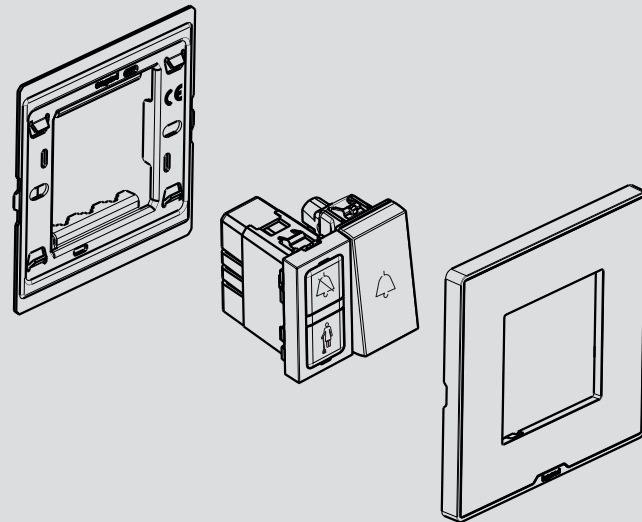

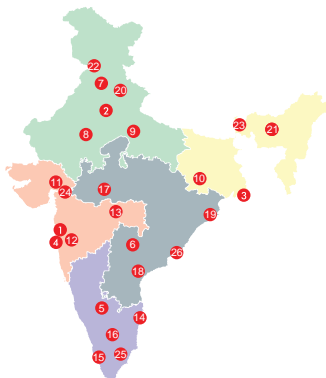

Head offices

- 61 & 62, 6th Floor,
Kalpataru Square, Kondivita Road,
Off Andheri-Kurla Road, Andheri (E),
MUMBAI – 400 059.
Tel : (022) 3041 6200
Fax : (022) 3041 6201
Website : www.legrand.co.in

Regional sales offices

- A-25, Mohan Co-operative
Industrial Estate, Mathura Road,
NEW DELHI - 110 044.
Tel : (011) 3990 2200, 2699 0046,
(011) 2699 0028 / 29 / 30 / 31
Fax : (011) 2699 0047
- Bhakta Towers, 2nd & 3rd Floor,
Plot No. KB 22, Sector-III, Saltlake,
KOLKATA – 700 098.
Tel : (033) 4021 3535 / 36
Fax : (033) 4021 3537
- C/203, Corporate Avenue, Atul Projects,
Near Mirador Hotel, Chakala,
Andheri Ghatkopar Link Road,
Andheri – East, **MUMBAI** – 400 099.
Tel : (022) 3385 6200 / 62301000 **INNOVAL**

- Ferozes Manor,
Situated at 58 Hospital Road,
Shivaji Nagar,
BANGALORE– 560 001.
Tel : (080) 6822 0000 **INNOVAL**
- 205-208, 2nd Floor, Block - II,
White House, Kundan Bagh,
Begumpet,
HYDERABAD – 500 016.
Tel : (040) 2341 4398 / 67, 4567 1717
Fax : (040) 6636 6974

Branch offices

- Unit 203, 2nd Floor, Tower- B,
Bestech Business Tower, Sector 66,
Mohali, **CHANDIGARH** -160066.
Telefax : (0141) 2208665, 666 **INNOVAL**
- 507-510, 5th Floor, Soni Paris Point,
Jai Singh Highway, Banipark,
JAIPUR – 302 016.
Tel / Fax : (0141) 220 8665 / 666
- 209-A, 2nd Floor, Cyber Heights,
Opp. Indira Gandhi Pratishthan,
Vibhuti Khand, Gomti Nagar
LUCKNOW- 226 010.
Tel : (522) 319 2031 / 32 / 33 **INNOVAL**
- 202 & 203, 2nd Floor, Sunrise,
Forum 100, Burdwan Compound, Lalpur,
RANCHI – 834 001.
- A 101-102, Mondeal Heights,
Besides Novotel Hotel, Sarkhej
Gandhinagar Highway [S G Highway],
AHMEDABAD – 380 015.
Tel : (079) 6134 0555 **INNOVAL**
- 402, Swastik Chambers,
Near Ashwamegh Marriage Hall,
Behind HP Petrol Pump,
Off Karve Road, Erandwane,
PUNE – 411 004.
Tel : (020) 6729 5601 / 602
Fax : (020) 6729 5604

- Plot No.95, II Floor, Shreyash Heights,
VIP Road, Ramdaspeth,
NAGPUR – 440 010.
Tel : (0712) 662 7857 / 858
Fax : (0712) 662 7859
- 10 B, (10th Floor), Prestige Center Court
Office Block Vijaya Forum Mall, #183,
N.S.K. Salai, Vadapalani
CHENNAI – 600 026.
Tel : (044) 6612 2800 / 2362 3125 / 35 / 45
Fax : (044) 2362 3165 **INNOVAL**
- J. B. Manjooran Estate,
Door No 50/1107A9, 3rd Floor,
Bye Pass Junction, Edappally,
COCHIN – 682 024.
Tel : (0484) 280 1921 / 2921, 658 0921 **INNOVAL**
- B-5, 1st Floor, Thirumalai Towers,
723, Avanashi Road,
COIMBATORE – 641 018.
Tel : (0422) 222 3634 / 668 3200 **INNOVAL**
- 204-205, Megapolis Square,
579, M G Road,
INDORE – 452 001.
Tel : (0731) 4999 891 / 892
- MF-2, Datta's Lords House,
Jammi Chettu Street, Mogalrajapuram,
VIJAYAWADA – 520 010.
Tel : (0866) 248 2393/6393/5393
- Plot No. 359, Saheed Nagar,
2nd Floor,
BHUBANESWAR – 751 007.
Tel : (0674) 254 0623
- Unit - 1 & 2, Vijay Park,
Main Chakrata Road,
DEHRADUN- 248 001.
Uttarakhand.
Tel : (0135) 661 6100 **INNOVAL**
- House No. 97, Ground Floor,
Rajgarh Main Road,
Opp. City Heart Nursing Home,
GUWAHATI – 781 007.
Tel : (0361) 245 8498

Area offices

- Cabin No. 9, Second Floor,
Madhok Trade Centre,
Madhok Complex, Ferozpur Road,
LUDHIANA – 141 001.
Tel : (0161) 277 0301 / 2 / 3 / 4
- 94, Udhm Singh Sarani,
Ground Floor, Ashrampara,
SILIGURI – 734 001.
Tel : (0353) 264 1067
- A-207, Universal Business
Center, Near Madhuvan circle,
L.P. Savani Road, Adajan,
SURAT – 395 009. **INNOVAL**
- Aparna Towers, 1st Floor, 2/3,
Bypass Road,
MADURAI – 625 010.
Telefax : (0452) 230 8414
- 43-9-205, Near srikanya theatre
3rd floor, Plot No 10, Subbalaskhmi
Nagar, Allipuram Ward,
Dondaparthi Area,
Vishakapathanam – 530 016.
Tel : (0891) 273 5652 / 9363 **INNOVAL**

Technical assistance from Legrand

Telephonic technical assistance for selection of products, technical information, guidance, wiring diagrams and estimation is now made available to you at each Regional Office. Contact the Technical Officer of Legrand at the following telephone numbers

New Delhi : Tel.: (011) 2699 0028, 3990 2200
Kolkata : Tel.: (033) 4021 3535 / 36
Mumbai : Tel.: (022) 3385 6200
Bangalore : Tel.: (080) 6822 0000
Hyderabad : Tel.: (040) 2341 4398 / 67, 4567 1717

For other places, contact the nearest Regional / Branch / Area offices

customer.care@legrand.co.in