

# Mylic™

A little touch of genius

## WALLS GET SMARTER AND BEAUTIFUL.



 **legrand**®

LIVE THE ADVANTAGE

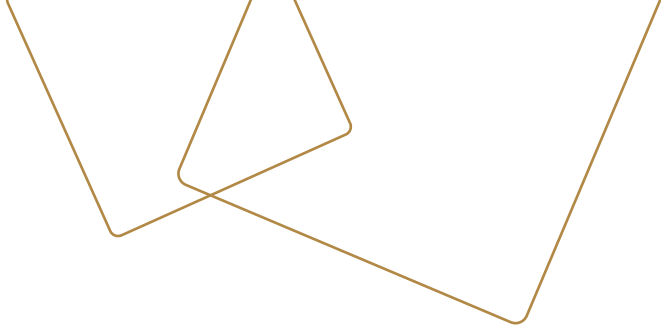

Today's lifestyle is constantly on the move. At Legrand, we meet the needs of this lifestyle with our technologically advanced products by investing 5% on R&D thereby making us the global specialist in electrical and digital building infrastructures.

We make things that are not just essential but even desirable. We pursue exacting engineering and fuel it with design thinking. We call this Designeering. It's not just a deep understanding of our markets, but delivering innovation and technology for uninterrupted living.

Such expertise helps us anticipate and fulfill the needs of our customers, making us the global leaders in wiring devices. Like the chic Mylinc, now made smarter with a host of features that help you live the advantage. Easy to install, convenient and with a range of new colours, Mylinc makes the walls of your home, establishment or office beautiful and smarter. Now, charge, surf, regulate, control and do a lot more with upgraded features.

**Live the advantage**





Remote Control Unit for Lights and Fan



RJ45 Socket with Shutter



25A Switch



Modular MCB



360° Rotation Fan Regulator



Skirting Light



USB Charger



Do Not Disturb &  
Make My Room Indicators

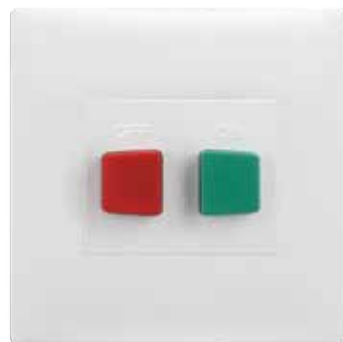

Motor Starter

# USB Charger



USB Charger in 1000 mA and 2000 mA capacities – IS Certified and tested under our stringent quality process, plug your electric and wifi enabled gadgets. Enjoy uninterrupted.



# 360° Rotation Fan Regulator

360° rotation to enable operation of the knob from any angle. Free movement for maximum comfort and convenience.

# Skirting Light in 2M



Highlight the special features in your home,  
office, establishment with stylish skirting lights.

# RJ 45 Socket with Shutter



Ambient dust lodges itself inside sockets, affecting performance. Keep out what is not needed.

# Remote Control Unit



Operate four lights and regulate one fan on infrared technology. Sometimes you just don't want to be interrupted from something important.





# Do Not Disturb & Make My Room Indicator

Minimalism in design with maximism in functionality is always in demand in hotels. We combine these elegantly in our switches for increased space savings.

# Motor Starter



Overload on heavy-duty appliances like air conditioners and geysers can cause damage. Give them the additional protection to keep them and you safe.

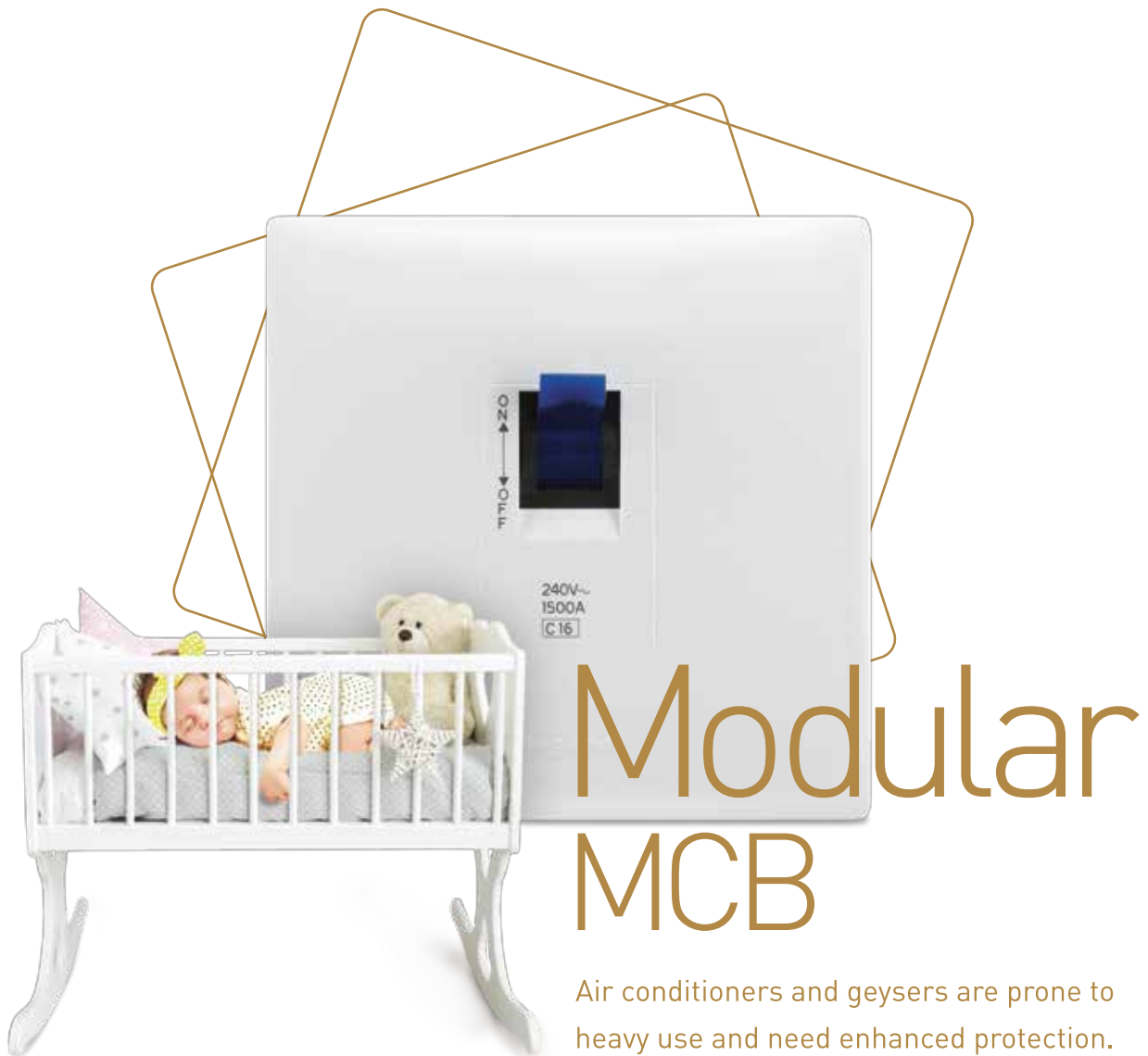

Air conditioners and geysers are prone to heavy use and need enhanced protection. Our MCBs are tested under strict quality process to keep you and your assets safe.



# Express with Colours

Choose from a rich, sophisticated colour palette.

Give the touch of taste and elegance to your smart walls.



# Moulded to Perfection

The white classic design is renowned for safety, reliability, convenience and beauty. The same exacting standards are now also available in moulded matt grey.



Screwless finish and rounded corners that add beauty to any home



Laser marking safeguards against fakes



Linc-Loc™ intelligent design prevents wrong fitting, misaligned switches and sockets



Indicators for correct orientation



Safety features for mishap-proof use



Front removal



Stripping Template

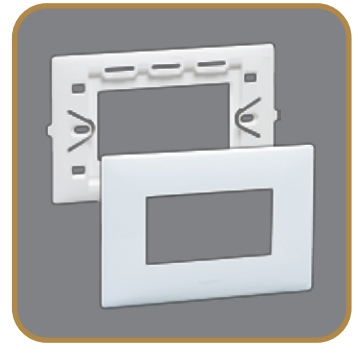

Modular Plates

Assuming a switch is operated 10 times a day on average, these switches come with a guarantee of one lakh operations

Dependable for One Lakh Operations



ISI Marking

# Mylic™ mechanisms

## switches and accessories



Switches are ISI marked as per the latest IS 3854:1997  
Silver plated screw terminals  
Linc-Loc™ Inter locking mechanisms for perfect alignment.  
Laser marking.

Pack	Cat.Nos	Switches	Number of modules	MRP*
20/200	6755 01	6 A one-way SP switch	1	104
20/200	6755 02	6 A two-way SP switch	1	154
20/200	6755 03	6 A one-way SP switch with indicator	1	182
20/200	6755 11	16 A one-way SP switch	1	174
20/200	6755 12	16 A two-way SP switch	1	220
20/200	6755 13	16 A one-way SP switch with indicator	1	232
10/100	<b>N</b> 6759 68*	Switch 25 A with indicator	1	274
10/100	6755 26	32 A one-way double pole switch with indicator	2	526
<b>Push buttons - *250 V~</b>				
20/200	6755 04	6 A one-way SP bell push	1	160
10/100	6755 06	6 A one-way SP bell push with indicator	2	328
<b>Bell call indicator &amp; register</b>				
20/200	6755 07	Bell call Indicator with register - 6 A one-way - *250 V~	1	876
<b>Lighting modules</b>				
for night Lamp.... neon light for 25000 hrs.				
20/200	6755 95	Indicator light red	1	194
20/200	6755 96	Indicator light orange	1	194
1/5/25	<b>N</b> 6755 97	Skirting light with white LED	3	652
5/50	6759 76*	Skirting light with white LED	2	442

\*Preferred voltage for IS 385 is 230 V~ and for IS 1293 is 240 V~  
\* to be shortly introduced  
\*MRP - Maximum Retail Price Inclusive of all taxes.  
**N** = New

# Mylic™ mechanisms

## dimmers and fan regulators



Conforming to IS 11037

Pack	Cat.Nos	Dimmers and fan regulators	Number of modules	MRP*
1/10/100	6755 35	Rotative dimmer 60 - 250 W for light	2	534
1/5/50	6755 33	Mylic dimmer 400 W for light	1	678
10/100	<b>N</b> 6759 64*	Fan regulator 100 W with 360° rotation	2	598
1/10/100	6755 30	Fan regulator 100 W, Humfree, 0-4 steps	2	646
1/5/50	<b>N</b> 6755 31	Fan regulator 100 W, Humfree, 0-4 steps	1	486
<b>Buzzer</b>				
20/200	6755 40	Mylic buzzer	1	588
<b>Remote unit</b>				
1/5/20	<b>N</b> 6759 75*	Remote control unit with remote for 4 switch & fan load	4	2960
<b>DND &amp; MMR</b>				
10/50	6755 56	DND & MMR external unit with bell push	3	310
10/100	<b>N</b> 6759 69*	DND & MMR external unit with bellpush	2	310
10/100	6755 57	Mylic internal control unit for DND & MMR	2	258
<b>Hotel key fob switch</b>				
1/10	6755 60	Hotel key fob switch - monobloc	M	2842
1	6730 38	Only key fob for 6755 60	-	162

\* to be shortly introduced  
\*MRP - Maximum Retail Price Inclusive of all taxes.  
**N** = New



# Mylic™ mechanisms

## energy sockets - power unit



Conforming to IS 1293 : 1988  
Shuttered for Child Safety  
Shutter opens only with phase and neutral  
insertion simultaneously.

Pack	Cat.Nos	Energy sockets	Number of modules	MRP*
10/100	<b>6755 50</b>	6 A - 2/3 pin combined	2	180
10/100	<b>6755 55</b>	6/16 A - 3 pin combined	2	288
10/100	6755 51	6 A - 3 pin	2	190
10/100	6755 52	Universal socket 6 A - 2/3 pin combined	2	222
20/200	6755 53	Euro-US-socket 6/16 A - 2 pin	1	278
10/100	<b>6755 54</b>	6/10/13 A - multistandard socket	2	290
<b>Power unit</b>				
5/25	6755 58	Power unit for 2 ton A.C and 3.5 KW geyser	4	1076
<b>Motor starter</b>				
1/10/100	<b>N</b> 6759 65*	Motor starter 16 A	2	500
<b>Modular MCB (IS : 60898-1:2002)</b>				
1/10/100	<b>N</b> 6759 74*	Modular SP MCB 16 A	1	326

\* to be shortly introduced  
\*MRP - Maximum Retail Price Inclusive of all taxes.  
**N** = New

# Mylic™ mechanisms - low voltage sockets,

## TV socket, RJ 11 telephone socket and accessories



Pack	Cat.Nos	Sockets	Number of modules	MRP*
Compatible with reception of antenna, satellite and cable network signals. Ø 9.5 mm connector TV female for co-axial cable				
20/200	<b>6755 46</b>	TV socket	1	160
20/200	<b>6755 41</b>	RJ 11 telephone socket	1	152
20/200	6755 44	Double RJ 11 telephone socket	1	254
20/200	6755 45	RJ 45 Cat 6 computer socket	1	554
20/200	6755 47	RJ 45 Cat 5e computer socket	1	398
20/200	<b>N</b> 6759 66*	RJ 45 socket Cat 5e with shutter	1	398
20/200	6759 67*	RJ 45 socket Cat 6 with shutter	1	554
<b>USB chargers (IS13252 (Part 1) / IEC 60950-1)</b>				
10/100	<b>N</b> 6759 71*	USB charger	1	710
10/100	6759 72*	Double USB charger	2	1125
<b>Accessories</b>				
20/200	<b>6755 91</b>	Cable outlet	1	144
20/200	<b>6755 90</b>	Blanking plate	1	36
20/200	6755 92	Spare 12 screws with nuts	-	54

\* to be shortly introduced  
\*MRP - Maximum Retail Price Inclusive of all taxes.  
**N** = New

# Mylic™ mechanisms matt grey

switches and accessories



# Mylic™ mechanisms matt grey

dimmers and fan regulators



6763 01 6763 03 6763 12 6763 04  
6763 07 6763 14 6763 15 6763 16



6763 17 6763 37 6763 21  
6763 42 6763 23 6763 24

Switches are ISI marked as per the latest IS 3854:1997  
Silver plated screw terminals  
Linc-Loc™ Inter locking mechanisms for perfect alignment.  
Laser marking.

Conforming to IS 11037

Pack	Cat.Nos	Switches	Number of modules	MRP*
		<b>6 A - *250 V~</b>		
20/200	6763 01	6 A one-way SP switch	1	114
20/200	6763 02	6 A two-way SP switch	1	170
20/200	6763 03	6 A one-way SP switch with indicator	1	200
		<b>16 A - *250 V~</b>		
20/200	6763 11	16 A one-way SP switch	1	192
20/200	6763 12	16 A two-way SP switch	1	242
20/200	6763 13	16 A one-way SP switch with indicator	1	256
		<b>25 A - *250 V~</b>		
10/100	6763 41*	Switch 25 A with indicator	1	302
		<b>32 A - *250 V~</b>		
20/200	6763 26	32 A one-way double pole switch with indicator	2	578
		<b>Push buttons - *250 V~</b>		
20/200	6763 04	6 A one-way SP bell push	1	176
10/100	6763 06	6 A one-way SP bell push with indicator	2	360
		<b>Bell call indicator &amp; register</b>		
20/200	6763 07	Bell call Indicator with register - 6 A one-way - *250 V~	1	964
		<b>Lighting modules</b>		
		for night Lamp.... neon light for 25000 hrs.		
20/200	6763 14	Indicator light red	1	214
20/200	6763 15	Indicator light orange	1	214
1/5/25	6763 16	Skirting light with white LED	3	718
5/50	6763 10*	Skirting light with white LED	2	486

Pack	Cat.Nos	Dimmers and fan regulators	Number of modules	MRP*
		<b>Dimmer with off and gradual dimming</b>		
1/10/100	6763 17	Rotative dimmer 60 - 250 W for light	2	588
1/5/50	6763 18	Rotative dimmer 60 - 400 W	1	746
10/100	6763 37*	Fan regulator 100 W with 360° rotation	2	658
1/10/100	6763 19	Fan regulator - 4 steps	2	710
1/5/50	6763 20	Fan regulator - 4 steps	1	534
		<b>Buzzer</b>		
20/200	6763 21	Mylicn buzzer	1	646
		<b>Remote unit</b>		
1/5/20	6763 47*	Remote control unit with remote for 4 switch & fan load	4	3256
		<b>DND &amp; MMR</b>		
		<b>Indicator lamp</b>		
10/50	6763 42*	DND & MMR external unit with bell push	1+1	342
10/100	6763 23	Mylicn internal control unit for DND & MMR	2	284
1/10	6763 24	Hotel key fob switch	M	3126
		<b>Hotel key fob switch</b>		
1/10	6730 38	Only key fob for 6755 60	-	162

\*Preferred voltage for IS 385 is 230 V~ and for IS 1293 is 240 V~  
\* to be shortly introduced  
\*MRP - Maximum Retail Price Inclusive of all taxes.  
N = New

# Mylic™ mechanisms

energy sockets - power unit



# Mylic™ mechanisms matt grey

low voltage / TV / RJ 11 telephone socket and accessories

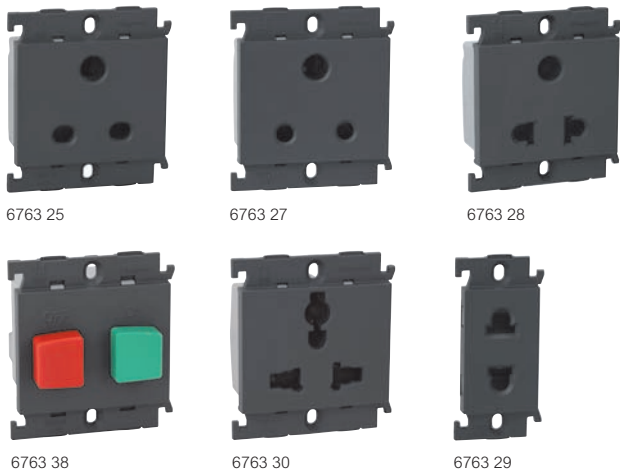

Conforming to IS 1293 : 1988  
Shuttered for Child Safety  
Shutter opens only with phase and neutral  
insertion simultaneously.

Pack	Cat.Nos	Energy sockets	Number of modules	MRP*
10/100	6763 25	6 A - 2/3 pin combined	2	198
10/100	6763 05	6/16 A - 3 pin combined	2	316
10/100	6763 27	6 A - 3 pin	2	210
10/100	6763 28	Universal socket 6 A - 2/3 pin combined	2	244
20/200	6763 29	Euro-US-socket 6/16 A	1	306
10/100	6763 30	6/10/13 A - multistandard socket	2	320
<b>Power unit</b>				
5/25	6763 31	Power unit for 2 ton A.C and 3.5 KW geyser	4	1184
<b>Motor starter</b>				
1/10/100	6763 38*	Motor starter 16 A	2	550
<b>Modular MCB (IS : 60898-1:2002)</b>				
1/10/100	6763 46*	Modular SP MCB 16 A	1	358

\* to be shortly introduced  
\*MRP - Maximum Retail Price Inclusive of all taxes.  
N = New

Pack	Cat.Nos	Sockets	Number of modules	MRP*
Compatible with reception of antenna, satellite and cable network signals. Ø 9.5 mm connector TV female for co-axial cable				
20/200	6763 32	TV socket	1	176
20/200	6763 33	RJ 11 telephone socket	1	168
20/200	6763 34	Double RJ 11 telephone socket	1	280
20/200	6763 39*	RJ 45 socket cat 5e with shutter	1	438
20/200	6763 40*	RJ 45 socket cat 6 with shutter	1	610
<b>USB chargers (IS13252(Part 1)/IEC 60950-1)</b>				
10/100	6763 43	USB charger	1	782
10/100	6763 44	Double USB charger	2	1238
<b>Accessories</b>				
20/200	6763 48	Cable outlet	1	158
20/200	6763 49	Blanking Plate 0.8 mm	1	40

\* to be shortly introduced  
\*MRP - Maximum Retail Price Inclusive of all taxes.  
N = New

# Mylic™ plates

modular white plates with frame



6755 61

6755 62



6755 69

Pack	Cat.Nos	White plates	Dimensions (mm) H x W	MRP*
		Superior finish, screwless, rounded corners dust proof, solid strength. Supported by plastic frame behind with flexible wall alignment. Horizontal adjustment facility.		
		<b>White plates</b>		
20/200	6755 61	For 1 module (square)	86 x 86	96
20/200	6755 62	For 2 modules (square)	86 x 86	96
10/100	6755 63	For 3 modules	86 x 121	130
10/100	6755 64	For 4 modules	86 x 146	140
5/50	6755 66	For 6 modules (2 column x 3)	86 x 224	178
5/50	6755 67	For 8 modules (2 column x 4)	86 x 245	232
5/25	6755 68	For 8 modules (2 row x 4)	172 x 146	234
5/50	6755 69	For 9 modules (3 column x 3)	86 x 288	272
10	6755 72	For 12 modules (2 row x 2 column x 3)	172 x 224	332
10	6755 73	For 16 modules (for specific box)	172 x 245	388
10	6755 78	For 18 modules (3 row x 2 column x 3)	240 x 224	522

\*MRP - Maximum Retail Price Inclusive of all taxes.

# Mylic™ plates

modular matt grey plates with frame



6763 50

6763 52



6763 55

Pack	Cat.Nos	Modular matt grey plates	Dimensions (mm) H x W	MRP*
		Superior finish, screwless, rounded corners dust proof, solid strength. Supported by plastic frame behind with flexible wall alignment. Horizontal adjustment facility.		
		<b>Matt grey plates</b>		
20/200	6763 50*	For 1 module (square)	86 x 86	124
20/200	6763 51	For 2 modules (square)	86 x 86	124
10/100	6763 52	For 3 modules	86 x 121	170
10/100	6763 53	For 4 modules	86 x 146	182
5/50	6763 54*	For 6 modules (2 column x 3)	86 x 224	232
5/50	6763 55*	For 8 modules (2 column x 4)	86 x 245	302
5/25	6763 56*	For 8 modules (2 row x 4)	172 x 146	304
5/50	6763 57	For 9 modules (3 column x 3)	86 x 288	354
10	6763 58*	For 12 modules (2 row x 2 column x 3)	172 x 224	432
10	6763 59	For 18 modules (3 row x 2 column x 3)	240 x 224	678

\* to be shortly introduced  
 \*MRP - Maximum Retail Price Inclusive of all taxes.  
 N = New

# Mylic™ plates

modular colour plates with frame



6763 60

6763 62



6763 65



6763 70

6763 72

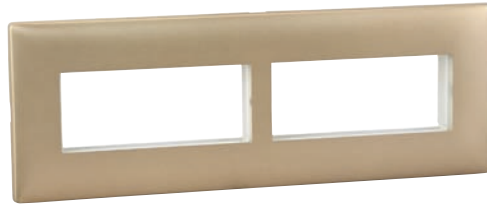

6763 75

Pack	Cat.Nos	Modular colour plates		Dimensions (mm) H x W	MRP*
		<b>Pearl white finish</b>			
		Superior finish, screwless, rounded corners dust proof, solid strength. Supported by plastic frame behind with flexible wall alignment. Horizontal adjustment facility.			
10/100	6763 60		For 1 module (square)	86 x 86	116
10/100	6763 61		For 2 modules (square)	86 x 86	116
10/100	6763 62		For 3 modules	86 x 121	156
10/100	6763 63		For 4 modules	86 x 146	168
5/50	6763 64*		For 6 modules (2 column x 3)	86 x 224	214
5/50	6763 65*		For 8 modules (2 column x 4)	86 x 245	278
5/25	6763 66*		For 8 modules (2 row x 4)	172 x 146	280
5/50	6763 67*		For 9 modules (3 column x 3)	86 x 288	326
5/25	6763 68*		For 12 modules (2 row x 2 column x 3)	172 x 224	398
5/25	6763 69*		For 18 modules (3 row x 2 column x 3)	240 x 224	626

\* to be shortly introduced  
 \*MRP - Maximum Retail Price Inclusive of all taxes.  
 N = New

Pack	Cat.Nos	Modular colour plates		Dimensions (mm) H x W	MRP*
		<b>Champagne finish</b>			
		Superior finish, screwless, rounded corners dust proof, solid strength. Supported by plastic frame behind with flexible wall alignment. Horizontal adjustment facility.			
10/100	6763 70*		For 1 module (square)	86 x 86	116
10/100	6763 71*		For 2 modules (square)	86 x 86	116
10/100	6763 72*		For 3 modules	86 x 121	156
10/100	6763 73*		For 4 modules	86 x 146	168
5/50	6763 74*		For 6 modules (2 column x 3)	86 x 224	214
5/50	6763 75*		For 8 modules (2 column x 4)	86 x 245	278
5/25	6763 76*		For 8 modules (2 row x 4)	172 x 146	280
5/50	6763 77*		For 9 modules (3 column x 3)	86 x 288	326
5/25	6763 78*		For 12 modules (2 row x 2 column x 3)	172 x 224	398
5/25	6763 79*		For 18 modules (3 row x 2 column x 3)	240 x 224	626

\* to be shortly introduced  
 \*MRP - Maximum Retail Price Inclusive of all taxes.  
 N = New

# Mylic™ plates

modular colour plates with frame



6763 80

6763 82

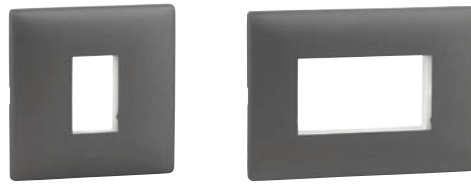

6763 90

6763 92



6763 85



6763 95

Pack	Cat.Nos	Modular colour plates		Dimensions (mm) H x W	MRP*
		Superior finish, screwless, rounded corners dust proof, solid strength. Supported by plastic frame behind with flexible wall alignment. Horizontal adjustment facility.			
		<b>Silver alu finish</b>			
10/100	6763 80		For 1 module (square)	86 x 86	116
10/100	6763 81		For 2 modules (square)	86 x 86	116
10/100	6763 82		For 3 modules	86 x 121	156
10/100	6763 83		For 4 modules	86 x 146	168
5/50	6763 84*		For 6 modules (2 column x 3)	86 x 224	214
5/50	6763 85*		For 8 modules (2 column x 4)	86 x 245	278
5/25	6763 86*		For 8 modules (2 row x 4)	172 x 146	280
5/50	6763 87*		For 9 modules (3 column x 3)	86 x 288	326
5/25	6763 88*		For 12 modules (2 row x 2 column x 3)	172 x 224	398
5/25	6763 89*		For 18 modules (3 row x 2 column x 3)	240 x 224	626

\* to be shortly introduced  
 \*MRP - Maximum Retail Price Inclusive of all taxes.  
 N = New

Pack	Cat.Nos	Modular colour plates		Dimensions (mm) H x W	MRP*
		Superior finish, screwless, rounded corners dust proof, solid strength. Supported by plastic frame behind with flexible wall alignment. Horizontal adjustment facility.			
		<b>Dark bronze finish</b>			
10/100	6763 90		For 1 module (square)	86 x 86	116
10/100	6763 91		For 2 modules (square)	86 x 86	116
10/100	6763 92		For 3 modules	86 x 121	156
10/100	6763 93		For 4 modules	86 x 146	168
5/50	6763 94*		For 6 modules (2 column x 3)	86 x 224	214
5/50	6763 95*		For 8 modules (2 column x 4)	86 x 245	278
5/25	6763 96*		For 8 modules (2 row x 4)	172 x 146	280
5/50	6763 97*		For 9 modules (3 column x 3)	86 x 288	326
5/25	6763 98*		For 12 modules (2 row x 2 column x 3)	172 x 224	398
5/25	6763 99*		For 18 modules (3 row x 2 column x 3)	240 x 224	626

\* to be shortly introduced  
 \*MRP - Maximum Retail Price Inclusive of all taxes.  
 N = New

# Mylic™ surrounds

## white modular surrounds









6755 81



6755 82

6755 89

Pack	Cat.Nos	White surrounds		Dimensions (mm) H x W	MRP*
		Superior finish, screwless appearance rounded corners, dust proof, for acrylic or hylem sheet or partition wall			
		<b>White surrounds</b>			
20/200	6755 81		For 1 module	61 x 34.4	42
20/200	6755 82		For 2 modules	61 x 58	74
10/100	6755 83		For 3 modules	61 x 81.6	74
10/100	6755 84		For 4 modules	61 x 105.2	108
10/100	6755 86		For 6 modules (2 column x 3)	61 x 162.5	154
10/100	6755 89		For 9 modules (3 column x 3)	61 x 243.5	270

\*MRP - Maximum Retail Price Inclusive of all taxes.

# Mylic™ boxes

## flush boxes



6890 07



6890 09

Sliding clamp for vertical adjustment













6890 10



6890 11



6890 12

Pack	Cat.Nos	Flush boxes for Mylic™ plate		Dimensions (mm) H x W x D	MRP*
		Factory made metal sheet enclosure top, bottom, side and back wall knockout for conduit entry from any direction. Possible to break open knockout without any special tool.			
40	6890 07		1 or 2 module	76.5 x 76.5 x 51.0	90
40	6890 08		3 modules	76.5 x 99.7 x 51.0	90
40	6890 09		4 modules	76.5 x 136.8 x 51.0	118
40	6890 10		6 modules	76.5 x 214.2 x 51.0	186
40	6890 42		8 modules	77.3 x 232.8 x 51.0	216
20	6890 31		8 modules (2 rows x 4)	136.8 x 136.6 x 61	214
20	6890 29		9 modules	77.3 x 279.3 x 51.2	254
10	6890 11		12 modules	145.3 x 215 x 61.2	324
10	6890 13		16 modules	232.8 x 147.4 x 61.2	374
10	6890 12		18 modules	213.3 x 215 x 61.2	412

\*MRP - Maximum Retail Price Inclusive of all taxes.

# Mylic™ boxes

## surface boxes



6733 03



6733 04



6890 21



6890 22

Pack	Cat.Nos	Plastic surface boxes for Mylic™ plate			
		Factory made enclosure offwhite shade top, bottom and back wall knockout for conduit entry / casing capping. Possible to break open knockout without any special tool.			
				Dimensions (mm) H x W x D	MRP*
10/50	6733 02		1/2 modules	86 x 86 x 45	86
5/35	6733 03		3 modules	86 x 121 x 45	104
5/25	6733 04		4 modules	86 x 146 x 45	120
1/10	6733 06		6 modules	86 x 224 x 45	152
1/5	6733 08		8 modules	86 x 245.2 x 45	226
1/5	6733 05		8 modules (2 rows x 4)	172 x 146 x 45	218
1/5	6740 99		9 modules	86 x 288 x 45	258

\*MRP - Maximum Retail Price Inclusive of all taxes.

Pack	Cat.Nos	Plastic surface boxes for Mylic™ plate			
		Factory made enclosure offwhite shade top, bottom and back wall knockout for conduit entry / casing capping. Possible to break open knockout without any special tool.			
				Dimensions (mm) H x W x D	MRP*
1/6	6890 21		Metal surface box 12 module (2 row x 6)	172 x 224 x 50	542
1/4	6890 22		Metal surface box 18 module (3 row x 6)	240 x 224 x 50	570

\*MRP - Maximum Retail Price Inclusive of all taxes.



# Mylinc™

## switches and accessories

### Technical data

#### Bell call indicator

Cat.Nos 6755 07 / 6763 07

#### Description

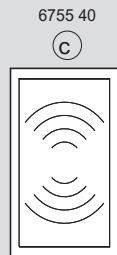
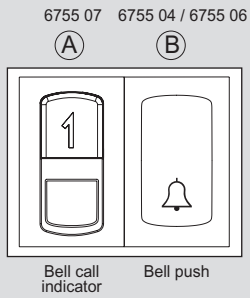

#### Wiring

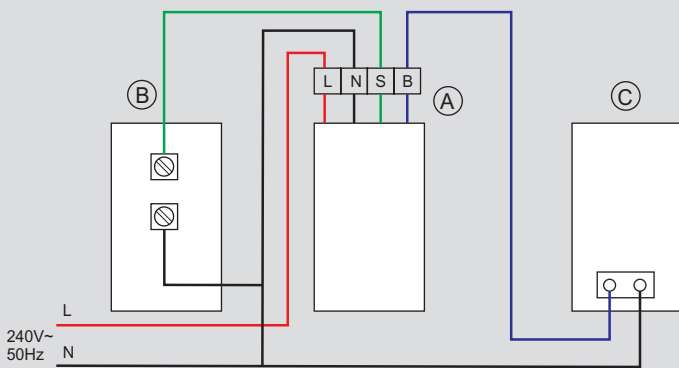

### Technical data

#### DND external unit

Cat.Nos 6755 56 / 6763 42 / 6763 42 / 6763 23

#### Description

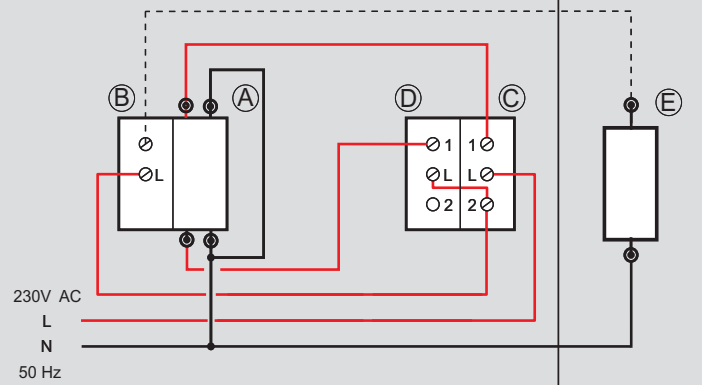
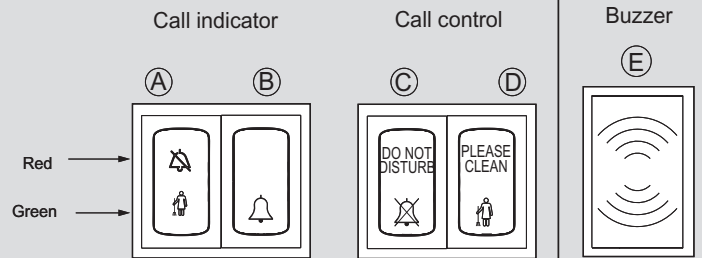

■ **Technical data**

**Remote control unit 4 M**

Cat.Nos 6759 75 / 6763 47

**Wiring diagram**

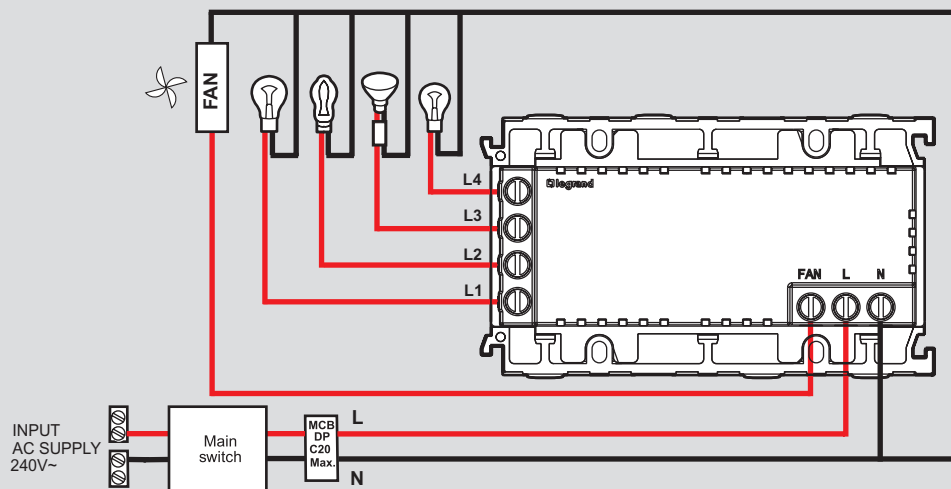

# Mylic™

power unit

## Technical data

### Modular MCB 1 M

Cat.Nos 6759 74 / 6763 46

### Wiring diagram

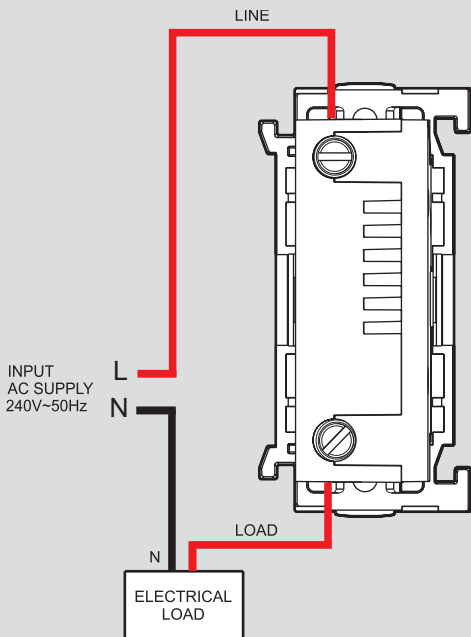

### Motor Starter 2 M

Cat.Nos 6759 65 / 6763 38

### Wiring diagram

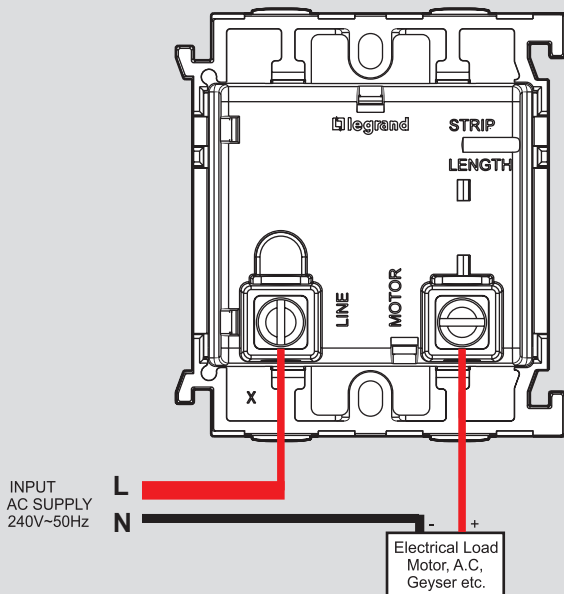

# Mylic™

socket and accessories

## Technical data

### USB chargers 1 M

(IS13252(Part 1)/IEC 60950-1)

Cat.Nos 6759 71 / 6763 43

### Wiring diagram

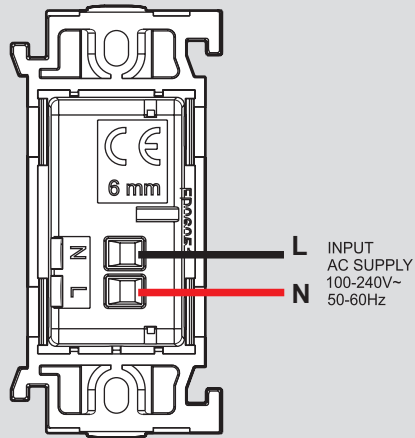

### USB chargers 2 M

(IS13252(Part 1)/IEC 60950-1)

Cat.No 6759 72 / 6763 44

### Wiring diagram

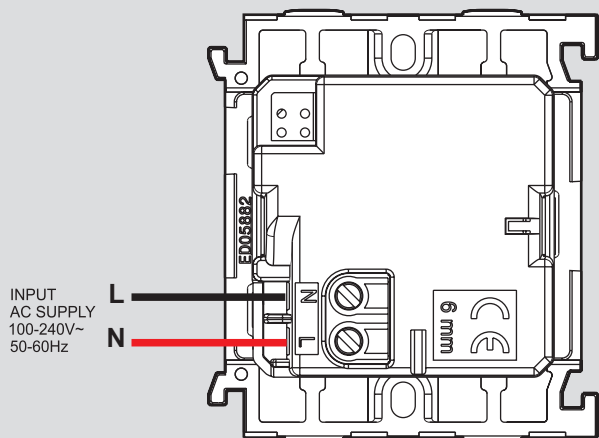

## HEAD OFFICE

61 & 62, 6<sup>th</sup> Floor, Kalpataru Square, Kondivita Road, Off Andheri-Kurla Road, Andheri (E), **MUMBAI** - 400 059.  
Tel : (022) 3041 6200 | Fax : (022) 3041 6201

## REGIONAL SALES OFFICES

A-25, Mohan Co-operative  
Industrial Estate, Mathura Road,  
**NEW DELHI** - 110 044.  
Tel : (011) 3990 2200, 2699 0046,  
(011) 2699 0028 / 29 / 30 / 31  
Fax : (011) 2699 0047

Bhakta Towers, 2nd & 3rd Floor,  
Plot No. KB 22, Sector-III, Salt Lake,  
**KOLKATA** - 700 098.  
Tel : (033) 4021 3535 / 36  
Fax : (033) 4021 3537

C/203, Corporate Avenue, Atul Projects,  
Near Mirador Hotel, Chakala,  
Andheri Ghatkopar Link Road,  
Andheri - East, **MUMBAI** - 400 099.  
Tel : (022) 3385 6200

10 B, (10th Floor), Prestige Center Court,  
Office Block, Vijaya Forum Mall, #183,  
N.S.K. Salai, Vadapalani,  
**CHENNAI** - 600 026.  
Tel : (044) 3024 7200 / 2362 3125 / 35 / 45  
Fax : (044) 2362 3165

205-208, 2nd Floor,  
Block - II, White House,  
Kundan Bagh, Begumpet,  
**HYDERABAD** - 500 016.  
Tel : (040) 2341 4398 / 67, 4567 1717  
Fax : (040) 4567 1730

## BRANCH OFFICES

SCO 1-2-3,  
Second Floor, Sector 17B,  
**CHANDIGARH** - 160 017.  
Tel : (0172) 305 8631 / 32 / 33 / 34 / 35  
Fax : (0172) 501 9008

507-510, Vth Floor,  
Soni Paris Point,  
Jai Singh Highway, Banipark,  
**JAIPUR** - 302 016.  
Telefax : (0141) 511 3129, 510 1179

209-A, 2nd Floor, Cyber Heights,  
Opp. Indira Gandhi Pratishthan,  
Vibhuti Khand, Gomti Nagar,  
**LUCKNOW** - 226 010.  
Tel : (0522) 319 2031 / 32 / 33

504, Sakar IV,  
Opp. M.J. Library, Ellis Bridge,  
**AHMEDABAD** - 380 006.  
Tel : (079) 2658 6561

402, Swastik Chambers,  
Near Ashwamegh Marriage Hall,  
Behind HP Petrol Pump,  
Off Karve Road, Erandwane,  
**PUNE** - 411 004.  
Tel : (020) 6729 5601 / 602  
Fax : (020) 6729 5604

Plot No.95, II Floor,  
Shreyash Heights,  
VIP Road, Ramdaspath,  
**NAGPUR** - 440 010.  
Tel : (0712) 662 7857 / 858  
Fax : (0712) 662 7859

2nd Floor,  
Al Latheef Building,  
2/1, Union Street,  
Off. Infantry Road,  
**BANGALORE** - 560 001.  
Tel : (080) 2286 1078, 4113 3293  
Fax : (080) 4113 3294

J. B. Manjooran Estate,  
Door No. 50/1107A9, 3rd Floor,  
Bypass Junction, Edappally,  
**COCHIN** - 682 024.  
Tel : (0484) 280 1921 / 2921, 658 0921  
Fax : (0484) 280 1921 / 2921

B-5, 1st Floor, Thirumalai Towers,  
723, Avanashi Road, **COIMBATORE** - 641 018.  
Tel : (0422) 650 2728, 222 3634 / 0283  
Fax : (0422) 222 3164

204-205, Megapolis Square,  
579, M G Road, **INDORE** - 452 001.  
Tel : (0731) 393 1650 / 51 / 52  
Fax : (0731) 393 1653

MF-2, Datta's Lords House,  
Jammii Chettu Street, Mogalrajapuram,  
**VIJAYAWADA** - 520 010.  
Tel : (0866) 661 1393, 664 6393  
Fax : (0866) 669 9393

## AREA OFFICES

ABC Business Club 16,  
Tagore Villa, **DEHRADUN** - 248 001.  
Tel : (0135) 271 5189  
Fax : (0135) 271 5580

Cabin No. 9, Second Floor,  
Madhok Trade Centre,  
Madhok Complex, Ferozpur Road,  
**LUDHIANA** - 141 001.  
Tel : (0161) 277 0301 / 2 / 3 / 4

House No. 97, Ground Floor,  
Rajgarh Main Road,  
Opp. City Heart Nursing Home,  
**GUWAHATI** - 781 007.  
Tel : (0361) 245 8498

94, Udham Singh Sarani,  
Ground Floor, Ashrampara,  
**SILIGURI** - 734 001.  
Tel : (0353) 264 1067

202 & 203, 2nd Floor,  
Sunrise, Forum 100,  
Burdwan Compound, Lalpur,  
**RANCHI** - 834 001.  
Tel : +91 9088104858

405, City Centre, Sosyo Circle,  
Udhana Magdalla Road,  
**SURAT** - 395 002.  
Tel : (0261) 263 3861

Aparna Towers, 1st Floor,  
2/3, Bypass Road,  
**MADURAI** - 625 010.  
Telefax : (0452) 230 8414

404, Eshwar Plaza,  
Dwaraka Nagar, Main Road,  
Beside Bata Show Room,  
**VISHAKHAPATNAM** - 530 016.  
Tel : (0891) 663 5652  
Fax : (0891) 663 9363

Plot No. 359,  
Saheed Nagar, 2nd Floor,  
**BHUBANESWAR** - 751 007.  
Tel : (0674) 254 0623

## Technical assistance from Legrand

Telephonic technical assistance for selection of products, technical information, guidance, wiring diagrams and estimation is now made available to you at each Regional Office. Contact the Technical Officer of Legrand at the following telephone numbers :

- New Delhi : (011) 2699 0028, 3990 2200
- Kolkata : (033) 4021 3535/36
- Mumbai : (022) 3385 6200
- Chennai : (044) 3024 7200
- Hyderabad : (040) 2341 4398 / 67, 4567 1717

For other places, contact the nearest Regional / Branch / Area offices customer.care@legrand.co.in



LIVE THE ADVANTAGE